

Compact cylinders ADVU/AEVU

FESTO

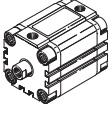
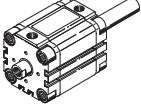
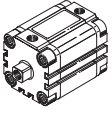
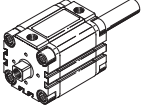
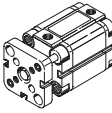
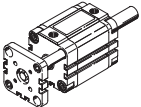
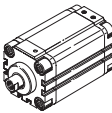

Product range overview

Function	Design	Type	Piston \varnothing [mm]	Stroke [mm]	Position sensing	
Double-acting	Basic version					
		ADVU Piston rod at one end	12, 16	5, 10, 15, 20, 25, 30, 40	1 ... 200	■
			20, 25	5, 10, 15, 20, 25, 30, 40, 50	1 ... 200	
			32, 40	5, 10, 15, 20, 25, 30, 40, 50, 60, 80	1 ... 300	
			50, 63	10, 15, 20, 25, 30, 40, 50, 60, 80	1 ... 300	
			80, 100, 125	10, 15, 20, 25, 30, 40, 50, 60, 80	1 ... 400	
		ADVU-...-S2 Through piston rod	12, 16, 20, 25	–	1 ... 200	■
			32, 40, 50, 63	–	1 ... 300	
			80, 100, 125	–	1 ... 400	
	Protected against rotation with square piston rod					
		ADVULQ Piston rod at one end	12, 16	5, 10, 15, 20, 25, 30, 40	1 ... 200	■
			20, 25	5, 10, 15, 20, 25, 30, 40, 50	1 ... 200	
			32, 40	5, 10, 15, 20, 25, 30, 40, 50, 60, 80	1 ... 300	
			50, 63	10, 15, 20, 25, 30, 40, 50, 60, 80	1 ... 300	
			80, 100	10, 15, 20, 25, 30, 40, 50, 60, 80	1 ... 400	
		ADVULQ-...-S2 Through piston rod	12, 16, 20, 25	–	1 ... 200	■
			32, 40, 50, 63	–	1 ... 300	
			80, 100	–	1 ... 400	
	Non-rotating with yoke					
		ADVUL Piston rod at one end	12, 16	5, 10, 15, 20, 25, 30, 40	1 ... 200	■
			20, 25	5, 10, 15, 20, 25, 30, 40, 50	1 ... 200	
			32, 40	5, 10, 15, 20, 25, 30, 40, 50, 60, 80	1 ... 300	
			50, 63	10, 15, 20, 25, 30, 40, 50, 60, 80	1 ... 300	
			80, 100	10, 15, 20, 25, 30, 40, 50, 60, 80	1 ... 400	
		ADVUL-...-S2 Through piston rod	12, 16, 20, 25	–	1 ... 200	■
			32, 40, 50, 63	–	1 ... 300	
			80, 100	–	1 ... 400	
Reinforced piston rod						
	ADVU-...-S1 Piston rod at one end	25	–	1 ... 500	■	
		40, 63	–	1 ... 2 000		
		100	–	1 ... 2 000		

Product range overview

Type	Piston rod		S20 Hollow piston rod	S6 Heat-resistant up to 120°C	R3 Increased corrosion protection	→ Page/Internet
	With female thread	With male thread				
Basic version						
ADVU Piston rod at one end	■	■	-	■	■	11
ADVU-...-S2 Through piston rod	■	■	■ ø 12 ... 100	■ ø 12 ... 100	-	11
Protected against rotation with square piston rod						
ADVULQ Piston rod at one end	■	■	-	■	-	22
ADVULQ-...-S2 Through piston rod	■	■	■ ø 16 ... 100	■	-	22
Non-rotating with yoke						
ADVUL Piston rod at one end	■	-	-	■	-	2
ADVUL-...-S2 Through piston rod	■	-	-	-	-	2
Reinforced piston rod						
ADVU-...-S1 Piston rod at one end	■	-	-	-	-	33

Product range overview

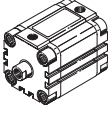
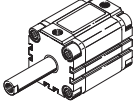
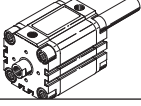
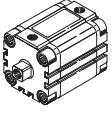
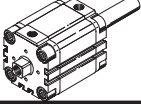
Function	Design	Type	Piston \varnothing [mm]	Stroke [mm]	Position sensing	
Single-acting	Basic version					
		AEVU Piston rod at one end Pushing	12	5, 10	1 ... 10	■
			16, 20, 25, 32, 40	5, 10, 15, 20, 25	1 ... 25	
			50, 63, 80, 100	10, 15, 20, 25	1 ... 25	
		AEVUZ Piston rod at one end Pulling	12	5, 10	1 ... 10	■
			16, 20, 25, 32, 40	5, 10, 15, 20, 25	1 ... 25	
			50, 63, 80, 100	10, 15, 20, 25	1 ... 25	
		AEVU-...-S2 Through piston rod Pushing	12	–	1 ... 10	■
			16, 20, 25, 32, 40, 50, 63, 80, 100	–	1 ... 25	
	Protected against rotation with square piston rod					
	AEVULQ Piston rod at one end Pushing	16, 20, 25, 32, 40	5, 10, 15, 20, 25	1 ... 25	■	
		50, 63, 80, 100	10, 15, 20, 25	1 ... 25		
	AEVULQ-...-S2 Through piston rod Pushing	16, 20, 25, 32, 40, 50, 63, 80, 100	–	1 ... 25	■	

Product range overview

Type	Piston rod		S20 Hollow piston rod	S6 Heat-resistant up to 120°C	R3 Increased corrosion protection	→ Page/Internet
	With female thread	With male thread				
Basic version						
AEVU Piston rod at one end Pushing	■	■	-	■	-	36
AEVUZ Piston rod at one end Pulling	■	■	-	■	-	36
AEVU-...-S2 Through piston rod Pushing	■	■	■	■	-	36
Protected against rotation with square piston rod						
AEVULQ Piston rod at one end Pushing	■	■	-	-	-	46
AEVULQ-...-S2 Through piston rod Pushing	■	■	-	-	-	46

Peripherals overview

Piston \varnothing 12 ... 100 mm

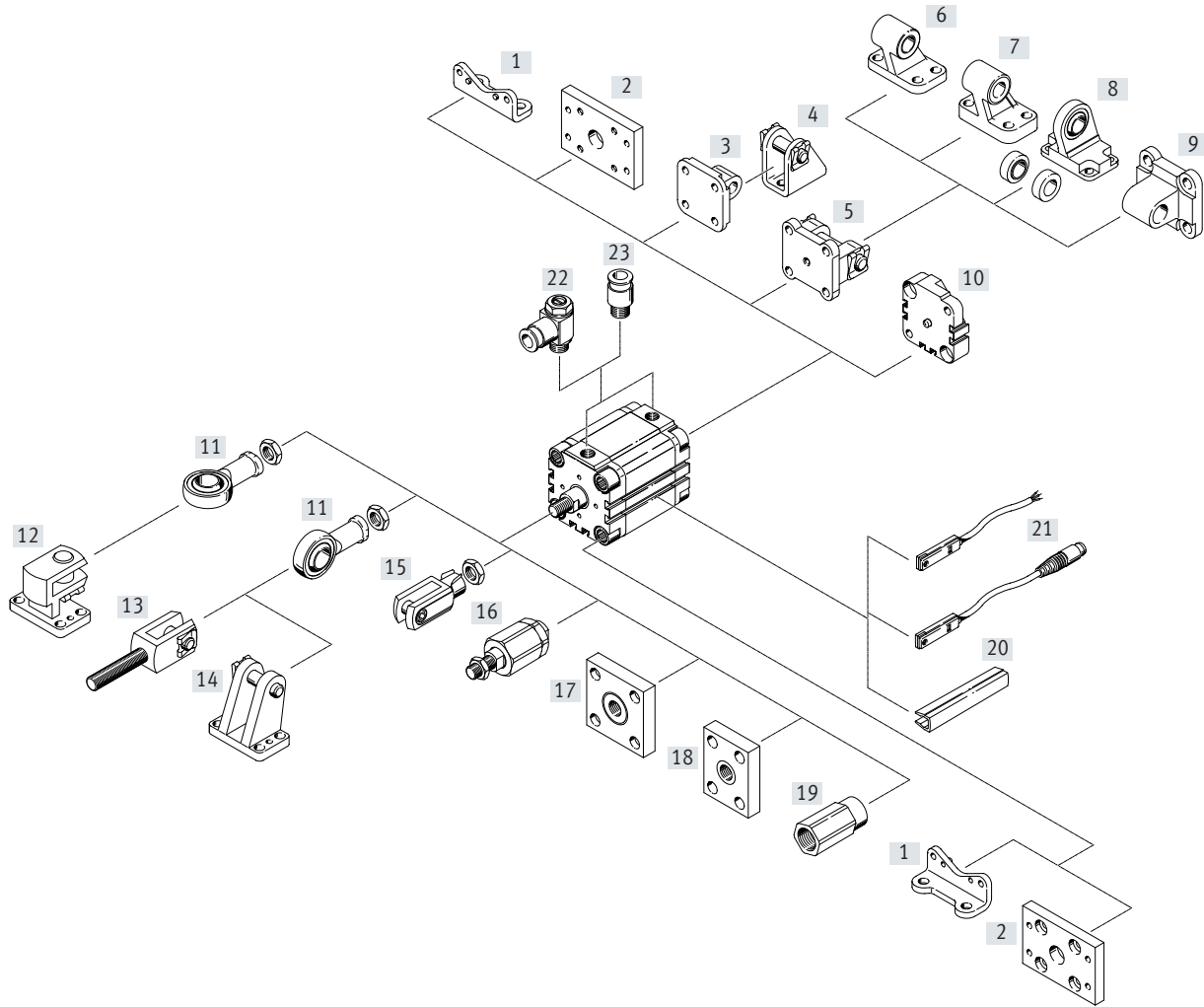

Variants

ADVU AEVU(Z)	S2/S20	ADVULQ AEVULQ	S2/S20	ADVU S1
-----------------	--------	------------------	--------	------------

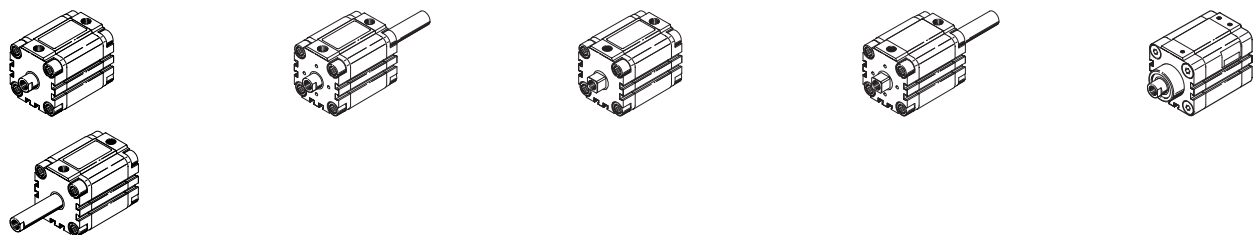

Peripherals overview

Mounting components and accessories		Description	ADVU AEVU(Z)		ADVULQ AEVULQ		ADVU	→ Page/Internet
				S2/S20		S2/S20	S1	
[1]	Foot mounting HUA/HUA-...-R3	For bearing and end caps	■	■	■	■	■	53
[2]	Flange mounting FUA	For bearing or end caps	■	■	■	■	■ ¹⁾	54
[3]	Swivel flange SUA/SUA-...-R3 for ø 12 ... 25/	For end caps	■	-	■	-	■	55
[4]	Clevis foot LBN/CRLBN	-	■	-	■	-	■	60
[5]	Swivel flange SUA/SUA-...-R3 for ø 32 ... 100/	For end caps	■	-	■	-	■	55
[6]	Clevis foot LN	-	■	-	■	-	■	60
[7]	Clevis foot LNG/CRLNG	-	■	-	■	-	■	60
[8]	Clevis foot LSN	With spherical bearing	■	-	■	-	■	60
[9]	Swivel flange SNCL	-	■	-	■	-	■	60
[10]	Mounting kit DPVU	For connecting two cylinders with the same piston diameter to form a multi-position cylinder	■	-	■	-	■	59
[11]	Rod eye SGS/CRSGS	With spherical bearing	■	■	-	-	■	62
[12]	Right-angle clevis foot LQG	-	■	■	-	-	■	60
[13]	Rod clevis SGA	With male thread	■	■	-	-	■	62
[14]	Clevis foot LBG/LBG-...-R3	-	■	■	-	-	■	60
[15]	Rod clevis SG/CRSG	Permits a swivelling movement of the cylinder in one plane	■	■	■	■	■	62
[16]	Self-aligning rod coupler FK/CRFK	To compensate for radial and angular deviations	■	■	-	-	■	62
[17]	Coupling piece KSG	To compensate for radial deviations	■	■	-	-	■	62
[18]	Coupling piece KSZ	For cylinders with a non-rotating piston rod to compensate for radial deviations	-	-	■	■	-	62
[19]	Adapters AD	For suction cup with connection	-	■ S20	-	■ S20	-	62
[20]	Slot cover ABP-5-S	For protecting the sensor cables and the sensor slots from contamination	■	■	■	■	■	64
[21]	Proximity switch SME/SMT-8	Can be integrated in the cylinder profile barrel	■	■	■	■	■	64
[22]	One-way flow control valve GRLA/GRLZ	For regulating speed	■	■	■	■	■	63
[23]	Push-in fitting QS	For connecting tubing with standard O.D.	■	■	■	■	■	q5

1) Only in combination with end cap

Peripherals overview

Piston \varnothing 125 mm

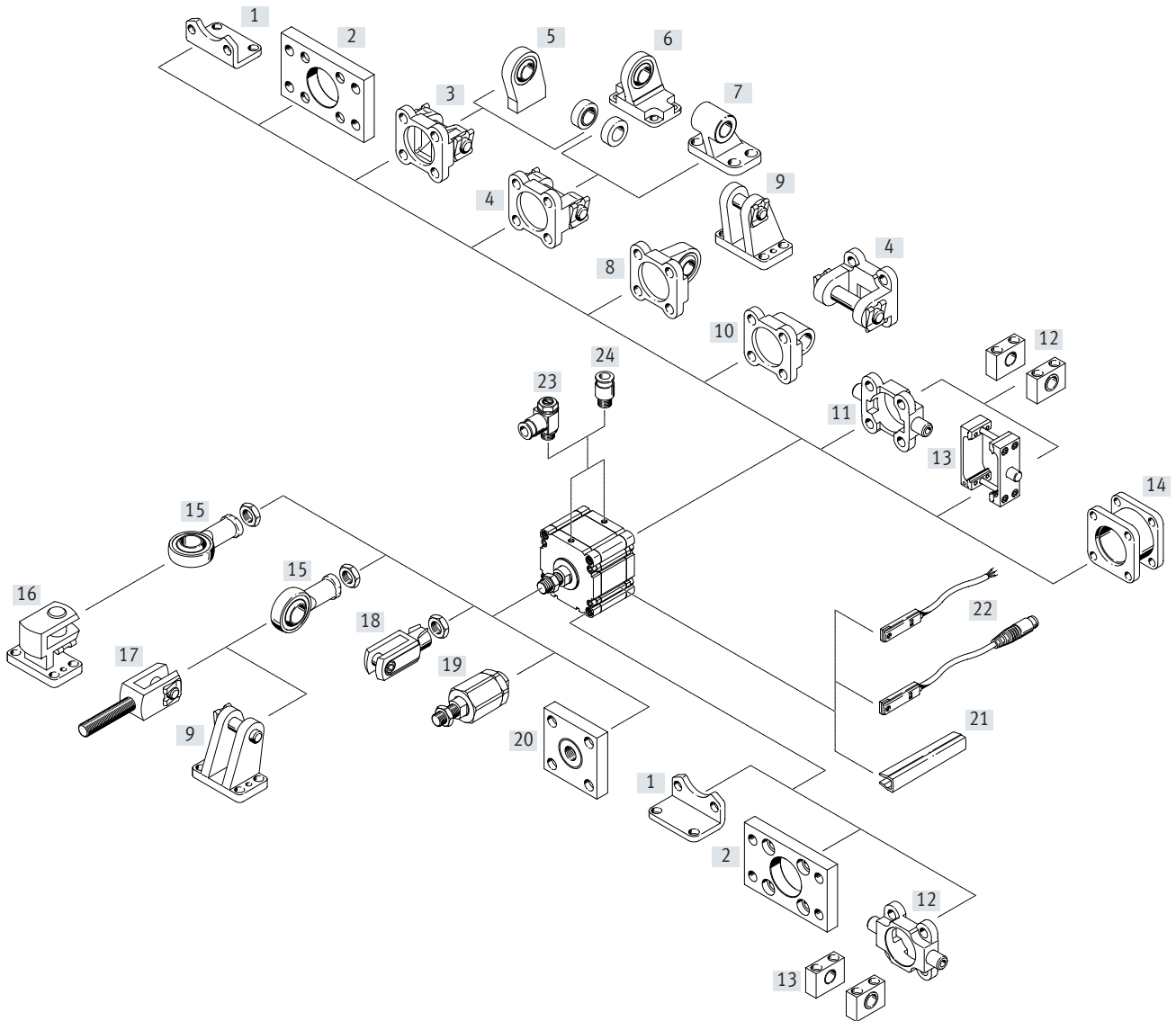

Peripherals overview

Mounting components and accessories		Description	ADVU		→ Page/Internet
				S2	
[1]	Foot mounting HNC/CRHNC	For bearing and end caps	■	■	53
[2]	Flange mounting FNC	For bearing or end caps	■	■	54
[3]	Swivel flange SNC	For end caps	■	–	56
[4]	Swivel flange SNCB/SNCB-...-R3	For end caps	■	–	56
[5]	Clevis foot LSNSG	Weld-on, with spherical bearing	■	–	60
[6]	Clevis foot LSN	With spherical bearing	■	–	60
[7]	Clevis foot LN	–	■	–	60
[8]	Swivel flange SNCS/SNCS-...-R3	With spherical bearing for end caps	■	–	57
[9]	Clevis foot LBG/LBG-...-R3	–	■	■	60
[10]	Swivel flange SNCL	For end caps	■	–	57
[11]	Trunnion flange ZNCF	For bearing or end caps	■	■	58
[12]	Trunnion support LNZG/CRLNZG	–	■	■	60
[13]	Trunnion mounting kit DAMT	For mounting anywhere along the cylinder profile barrel	■	■	58
[14]	Mounting kit DPNC	For connecting two cylinders with the same piston diameter to form a multi-position cylinder	■	■	59
[15]	Rod eye SGS/CRSGS	With spherical bearing	■	■	62
[16]	Right-angle clevis foot LQG	–	■	■	60
[17]	Rod clevis SGA	With male thread	■	■	62
[18]	Rod clevis SG/CRSG	Permits a swivelling movement of the cylinder in one plane	■	■	62
[19]	Self-aligning rod coupler FK/CRFK	To compensate for radial and angular deviations	■	■	62
[20]	Coupling piece KSG	To compensate for radial deviations	■	■	62
[21]	Slot cover ABP-5-S	For protecting the sensor cables and the sensor slots from contamination	■	■	64
[22]	Proximity switch SME/SMT-8	Can be integrated in the cylinder profile barrel	■	■	64
[23]	One-way flow control valve GRLA/GRLZ	For regulating speed	■	■	63
[24]	Push-in fitting QS	For connecting tubing with standard O.D.	■	■	QS

Type codes

001	Series	
ADVU	Compact cylinder, double-acting	
ADVULQ	Compact cylinder, double-acting, square piston rod	
AEVU	Compact cylinder, single-acting	
AEVUZ	Compact cylinder, single-acting, pulling	
AEVULQ	Compact cylinder, single-acting, square piston rod	

002	Piston diameter	
12	12	
16	16	
20	20	
25	25	
32	32	
40	40	
50	50	
63	63	
80	80	
100	100	
125	125	

003	Stroke	
...	1 ... 2000	

004	Piston rod thread type	
	Female thread	
A	Male thread	

005	Cushioning	
P	Elastic cushioning rings/plates on both sides	

006	Position sensing	
A	For proximity sensor	

007	Piston rod type	
	At one end	
S1	Reinforced piston rod	
S2	Through piston rod	
S20	Through, hollow piston rod	
S26	Through piston rod, heat-resistant seals max. 120 °C	
S206	Through, hollow piston rod, heat-resistant seals max. 120 °C	

008	Temperature range	
	Standard	
S6	Heat-resistant seals max. 120 °C	

009	Corrosion protection	
	Standard	
R3	High corrosion protection	

Data sheet – Double-acting, basic version

Function

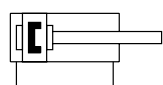

⌀ Diameter
12 ... 125 mm

Stroke length
1 ... 400 mm

www.festo.com
Sets of wearing parts
→ page 21

Variants

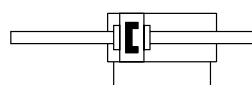

S2

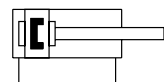

S6

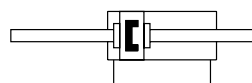

S26

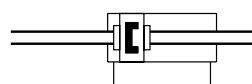

S20

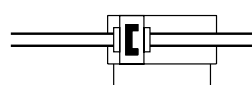

S206

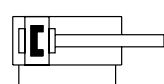

R3

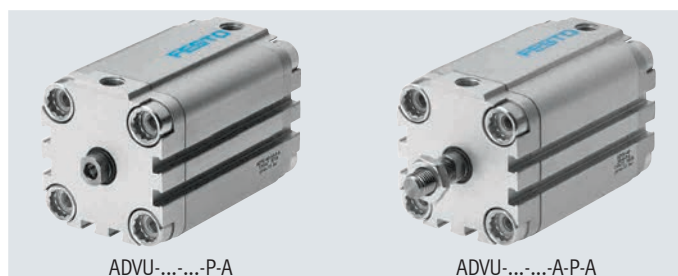

ADVU-...-P-A

ADVU-...-A-P-A



ADVU-...-P-A-S2

ADVU-...-A-P-A-S20

General technical data

Piston Ø	12	16	20	25	32	40	50	63	80	100	125	
Pneumatic connection	M5	M5	M5	M5	G1/8	G1/8	G1/8	G1/8	G1/8	G1/4	G1/4	
Piston rod end	Female thread	M3	M4	M5	M5	M6	M6	M8	M8	M10	M12	M16
	Male thread	M6	M8	M10x1.25				M12x1.25		M16x1.5	M20x1.5	M27x2
Operating medium	Compressed air to ISO 8573-1:2010 [7:4:4]											
Note on the operating/ pilot medium	Lubricated operation possible (in which case lubricated operation will always be required)											
Design	Piston											
	Piston rod											
Cushioning	Elastic cushioning rings/pads at both ends											
Position sensing	Via proximity switch											
Type of mounting	Via through-hole											
	With female thread											
	With accessories											
Mounting position	Any											

Note

This product conforms to ISO 1179-1 and ISO 228-1

Operating pressure [bar]

Piston Ø	12	16	20	25	32	40	50	63	80	100	125
Piston rod at one end	1.2 ... 10		1.0 ... 10		0.8 ... 10			0.6 ... 10		0.5 ... 10	
Through piston rod S2/S20	1.5 ... 10	1.3 ... 10	1.2 ... 10		1.0 ... 10			0.8 ... 10		0.5 ... 10	

Environmental conditions

Compact cylinder	Basic version	S6	R3
Ambient temperature ¹⁾ [°C]	-20 ... +80	0 ... +120	
Corrosion resistance class CRC ²⁾	2	2	3

1) Note operating range of proximity switches

2) Corrosion resistance class CRC 2 to Festo standard FN 940070

Moderate corrosion stress. Indoor applications in which condensation can occur. External visible parts with primarily decorative surface requirements which are in direct contact with a normal industrial environment.

Corrosion resistance class CRC 3 to Festo standard FN 940070

High corrosion stress. Outdoor exposure under moderate corrosive conditions. External visible parts with primarily functional surface requirements which are in direct contact with a normal industrial environment.

Data sheet – Double-acting, basic version

Forces [N] and impact energy [J]												
Piston ø		12	16	20	25	32	40	50	63	80	100	125
Theoretical force at 6 bar, advancing		68	121	188	295	483	754	1178	1870	3016	4712	7363
	S2/S20	51	90	141	247	415	686	1057	1750	2827	4418	6881
Theoretical force at 6 bar, retracting		51	90	141	247	415	686	1057	1750	2827	4418	6881
	S2/S20	51	90	141	247	415	686	1057	1750	2827	4418	6881
Max. impact energy at the end positions		0.07	0.10	0.14	0.30	0.40	0.52	0.64	0.70	0.75	1.00	3.3
	S20	0.01	0.01	0.01	0.01	0.04	0.05	0.06	0.07	0.08	0.10	0.40

Maximum permissible mass:

$$v = \sqrt{\frac{2 \cdot E}{m_1 + m_2}}$$

Permissible impact velocity:

$$m_2 = \frac{2 \cdot E}{v^2} - m_1$$

v Permissible impact velocity

E Max. impact energy

m₁ Moving mass (drive)

m₂ Moving payload

Note
These specifications represent the maximum values that can be achieved. The maximum permissible impact energy must be observed.

Note
ProPneu engineering software
→ www.festo.com

Max. lateral force F_q as a function of the projection x

Piston rod at one end

Through piston rod

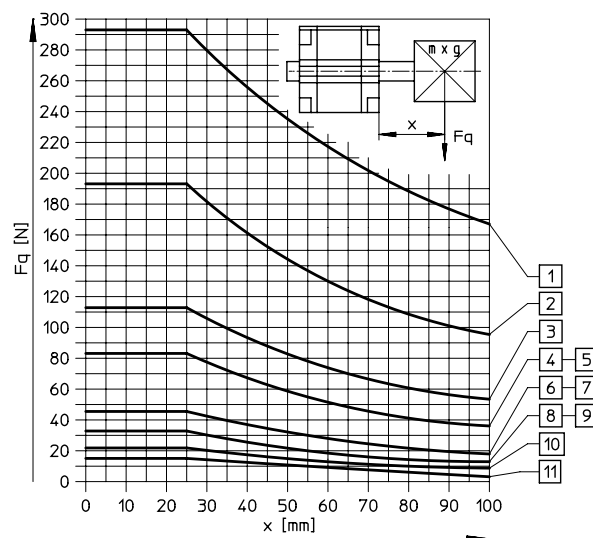
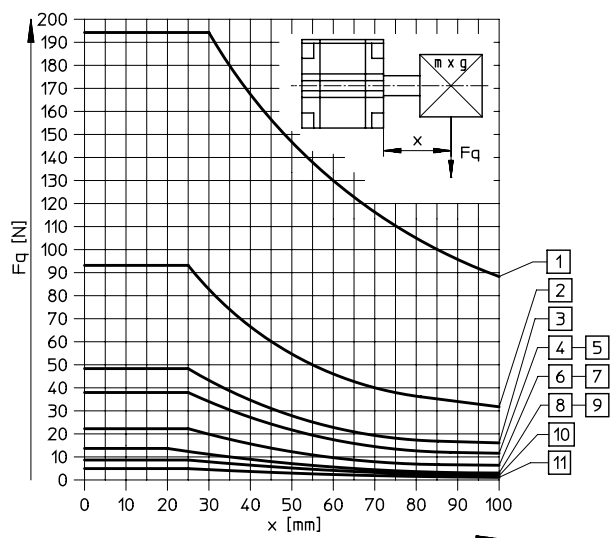

- [1] ø 125 mm
- [2] ø 100 mm
- [3] ø 80 mm
- [4] ø 63 mm

- [5] ø 50 mm
- [6] ø 40 mm
- [7] ø 32 mm
- [8] ø 25 mm

- [9] ø 20 mm
- [10] ø 16 mm
- [11] ø 12 mm

Data sheet – Double-acting, basic version

Weight [g]											
Piston \varnothing	12	16	20	25	32	40	50	63	80	100	125
Product weight with 0 mm stroke	87	89	149	180	300	433	560	1059	1772	2797	3426
Additional weight per 10 mm stroke	15	15	23	28	40	59	72	107	168	177	168
Moving mass with 0 mm stroke	8	12	20	26	49	63	112	134	307	614	1317
Additional mass per 10 mm stroke	2	4	6	6	9	9	16	16	25	38	63

Materials

Sectional view

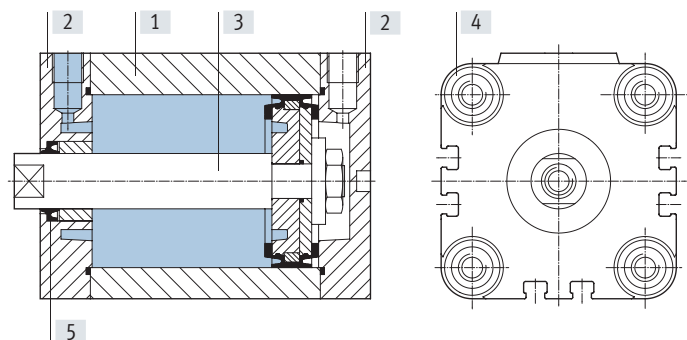

Compact cylinder		Basic version	S6	R3
[1]	Cylinder barrel	Wrought aluminium alloy	Wrought aluminium alloy	Wrought aluminium alloy
[2]	Cover	Wrought aluminium alloy	Wrought aluminium alloy	Wrought aluminium alloy
[3]	Piston rod	\varnothing 12 ... 32	High-alloy stainless steel	High-alloy stainless steel
		\varnothing 40 ... 125	High-alloy steel	High-alloy stainless steel
[4]	Flange screws	\varnothing 12 ... 16	High-alloy stainless steel	High-alloy stainless steel
		\varnothing 20 ... 125	Galvanised steel	High-alloy stainless steel
[5]	Dynamic seals	Polyurethane	Fluoro rubber	Polyurethane

Data sheet – Double-acting, basic version

Dimensions – Basic cylinders

Download CAD data → www.festo.com

Piston \varnothing 12 ... 100 mm

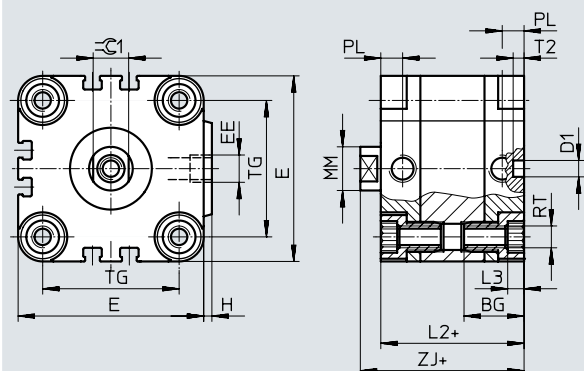

Note
To mount from above with piston diameter 12 and 16 mm, only use 2 diagonal screws or use non-magnetic screws.

+ = plus stroke length
[2] Minimum screw-in depth

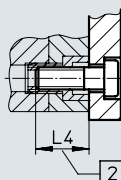

Piston \varnothing 125 mm

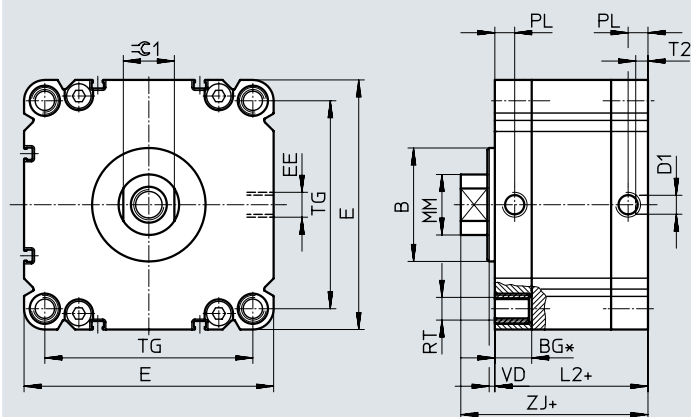

Note
* Minimum screw-in depth 18mm. Cannot be screwed through with socket head screw.

+ = plus stroke length

\varnothing [mm]	B d11	BG	D1 \varnothing H9	E	EE	H	L2	L3	L4	MM \varnothing	PL	RT	T2	TG	VD	ZJ	\approx C1 h13
12	-	18.5	6	29	M5	1	38	3	16	6	8	M4	4	18	-	42.5	5
16	-	18.5	6	29	M5	1	38	3	16	8	8	M4	4	18	-	42.5	7
20	-	18.5	6	36	M5	1.5	38	4	18	10	8	M5	4	22	-	42.5	9
25	-	18.5	6	40	M5	1.5	39.5	4	18	10	8	M5	4	26	-	45	9
32	-	21.5	6	50	G1/8	2	44.5	5	20	12	8	M6	4	32	-	50.5	10
40	-	21.5	6	60	G1/8	2.5	45.5	5	20	12	8	M6	4	42	-	52	10
50	-	22	6	68	G1/8	3	45.5	6	20	16	8	M8	4	50	-	53	13
63	-	24.5	8	87	G1/8	4	50	8	25	16	8	M10	4	62	-	57.5	13
80	-	27.5	8	107	G1/8	4	56	8	25	20	8.5	M10	4	82	-	64	17
100	-	32.5	8	128	G1/4	5	66.5	8	25	25	10.5	M10	4	103	-	76.5	22
125	60	19.5	10	132	G1/4	-	81	-	18	32	10.5	M12	6	110	4	99	27

Note
This product conforms to ISO 1179-1 and ISO 228-1

Data sheet – Double-acting, basic version

Dimensions – Variants

Download CAD data → www.festo.com

Basic version

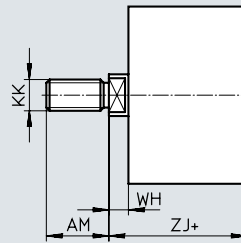
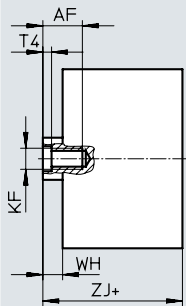

S2 – Through piston rod

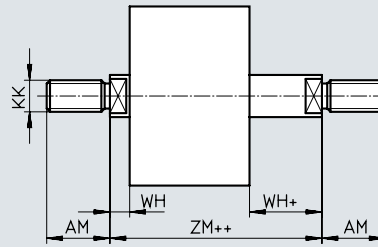
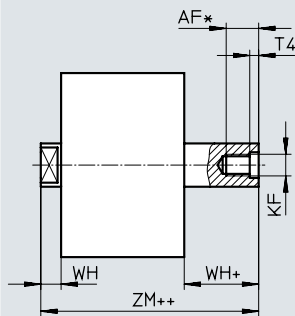

S20 – Through, hollow piston rod

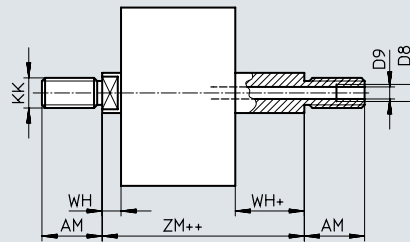

- + = plus stroke length
++ = plus 2x stroke length

∅ [mm]	AF	AM	D8	D9 ∅	KF	KK	T4	WH	ZJ	ZM
12	8	16	–	2.3	M3	M6	1.5	4.5	42.5	47
16	10	20	–	3.2	M4	M8	1.5	4.5	42.5	47
20 ²⁾	12	22	–	3.8	M5	M10x1.25	2	4.5	42.5	47
25 ²⁾	12	22	–	3.8	M5	M10x1.25	2	5.5	45	50.5
32 ²⁾	14	22	–	4.5	M6	M10x1.25	2.6	6	50.5	56.5
40 ²⁾	14	22	–	4.5	M6	M10x1.25	2.6	6.5	52	58.5
50 ²⁾	16	24	–	6	M8	M12x1.25	3.3	7.5	53	60.5
63 ²⁾	16	24	–	6	M8	M12x1.25	3.3	7.5	57.5	65
80 ²⁾	20 ¹⁾	32	G1/8	8	M10	M16x1.5	4.7	8	64	72
100 ²⁾	24 ¹⁾	40	G1/4	11.7	M12	M20x1.5	6.1	10	76.5	86.5
125 ²⁾	25 ¹⁾	54	–	–	M16	M27x2	7	18	99	117

- 1) With a stroke < 5 mm, the maximum screw-in depth is reduced by 5 mm
2) Nut for piston rod thread included in the scope of delivery

Data sheet – Double-acting, basic version

Ordering data – Basic version					
Piston ø [mm]	Stroke [mm]	Piston rod with female thread		Piston rod with male thread	
		Part no.	Type	Part no.	Type
12	5	156500	ADVU-12-5-P-A	156586	ADVU-12-5-A-P-A
	10	156501	ADVU-12-10-P-A	156587	ADVU-12-10-A-P-A
	15	156502	ADVU-12-15-P-A	156588	ADVU-12-15-A-P-A
	20	156503	ADVU-12-20-P-A	156589	ADVU-12-20-A-P-A
	25	156504	ADVU-12-25-P-A	156590	ADVU-12-25-A-P-A
	30	156505	ADVU-12-30-P-A	156591	ADVU-12-30-A-P-A
	40	156506	ADVU-12-40-P-A	156592	ADVU-12-40-A-P-A
16	5	156507	ADVU-16-5-P-A	156593	ADVU-16-5-A-P-A
	10	156508	ADVU-16-10-P-A	156594	ADVU-16-10-A-P-A
	15	156509	ADVU-16-15-P-A	156595	ADVU-16-15-A-P-A
	20	156510	ADVU-16-20-P-A	156596	ADVU-16-20-A-P-A
	25	156511	ADVU-16-25-P-A	156597	ADVU-16-25-A-P-A
	30	156512	ADVU-16-30-P-A	156598	ADVU-16-30-A-P-A
	40	156513	ADVU-16-40-P-A	156599	ADVU-16-40-A-P-A
20	5	156514	ADVU-20-5-P-A	156600	ADVU-20-5-A-P-A
	10	156515	ADVU-20-10-P-A	156601	ADVU-20-10-A-P-A
	15	156516	ADVU-20-15-P-A	156602	ADVU-20-15-A-P-A
	20	156517	ADVU-20-20-P-A	156603	ADVU-20-20-A-P-A
	25	156518	ADVU-20-25-P-A	156604	ADVU-20-25-A-P-A
	30	156519	ADVU-20-30-P-A	156605	ADVU-20-30-A-P-A
	40	156520	ADVU-20-40-P-A	156606	ADVU-20-40-A-P-A
	50	156521	ADVU-20-50-P-A	156607	ADVU-20-50-A-P-A
25	5	156522	ADVU-25-5-P-A	156608	ADVU-25-5-A-P-A
	10	156523	ADVU-25-10-P-A	156609	ADVU-25-10-A-P-A
	15	156524	ADVU-25-15-P-A	156610	ADVU-25-15-A-P-A
	20	156525	ADVU-25-20-P-A	156611	ADVU-25-20-A-P-A
	25	156526	ADVU-25-25-P-A	156612	ADVU-25-25-A-P-A
	30	156527	ADVU-25-30-P-A	156613	ADVU-25-30-A-P-A
	40	156528	ADVU-25-40-P-A	156614	ADVU-25-40-A-P-A
	50	156529	ADVU-25-50-P-A	156615	ADVU-25-50-A-P-A
32	5	156530	ADVU-32-5-P-A	156616	ADVU-32-5-A-P-A
	10	156531	ADVU-32-10-P-A	156617	ADVU-32-10-A-P-A
	15	156532	ADVU-32-15-P-A	156618	ADVU-32-15-A-P-A
	20	156533	ADVU-32-20-P-A	156619	ADVU-32-20-A-P-A
	25	156534	ADVU-32-25-P-A	156620	ADVU-32-25-A-P-A
	30	156535	ADVU-32-30-P-A	156621	ADVU-32-30-A-P-A
	40	156536	ADVU-32-40-P-A	156622	ADVU-32-40-A-P-A
	50	156537	ADVU-32-50-P-A	156623	ADVU-32-50-A-P-A
	60	156538	ADVU-32-60-P-A	156624	ADVU-32-60-A-P-A
	80	156539	ADVU-32-80-P-A	156625	ADVU-32-80-A-P-A

Data sheet – Double-acting, basic version

Ordering data – Basic version					
Piston Ø [mm]	Stroke [mm]	Piston rod with female thread		Piston rod with male thread	
		Part no.	Type	Part no.	Type
40	5	156540	ADVU-40-5-P-A	156626	ADVU-40-5-A-P-A
	10	156541	ADVU-40-10-P-A	156627	ADVU-40-10-A-P-A
	15	156542	ADVU-40-15-P-A	156628	ADVU-40-15-A-P-A
	20	156543	ADVU-40-20-P-A	156629	ADVU-40-20-A-P-A
	25	156544	ADVU-40-25-P-A	156630	ADVU-40-25-A-P-A
	30	156545	ADVU-40-30-P-A	156631	ADVU-40-30-A-P-A
	40	156546	ADVU-40-40-P-A	156632	ADVU-40-40-A-P-A
	50	156547	ADVU-40-50-P-A	156633	ADVU-40-50-A-P-A
	60	156548	ADVU-40-60-P-A	156634	ADVU-40-60-A-P-A
	80	156549	ADVU-40-80-P-A	156635	ADVU-40-80-A-P-A
50	10	156550	ADVU-50-10-P-A	156636	ADVU-50-10-A-P-A
	15	156551	ADVU-50-15-P-A	156637	ADVU-50-15-A-P-A
	20	156552	ADVU-50-20-P-A	156638	ADVU-50-20-A-P-A
	25	156553	ADVU-50-25-P-A	156639	ADVU-50-25-A-P-A
	30	156554	ADVU-50-30-P-A	156640	ADVU-50-30-A-P-A
	40	156555	ADVU-50-40-P-A	156641	ADVU-50-40-A-P-A
	50	156556	ADVU-50-50-P-A	156642	ADVU-50-50-A-P-A
	60	156557	ADVU-50-60-P-A	156643	ADVU-50-60-A-P-A
		80	156558	ADVU-50-80-P-A	156644
63	10	156559	ADVU-63-10-P-A	156645	ADVU-63-10-A-P-A
	15	156560	ADVU-63-15-P-A	156646	ADVU-63-15-A-P-A
	20	156561	ADVU-63-20-P-A	156647	ADVU-63-20-A-P-A
	25	156562	ADVU-63-25-P-A	156648	ADVU-63-25-A-P-A
	30	156563	ADVU-63-30-P-A	156649	ADVU-63-30-A-P-A
	40	156564	ADVU-63-40-P-A	156650	ADVU-63-40-A-P-A
	50	156565	ADVU-63-50-P-A	156651	ADVU-63-50-A-P-A
	60	156566	ADVU-63-60-P-A	156652	ADVU-63-60-A-P-A
		80	156567	ADVU-63-80-P-A	156653
80	10	156568	ADVU-80-10-P-A	156654	ADVU-80-10-A-P-A
	15	156569	ADVU-80-15-P-A	156655	ADVU-80-15-A-P-A
	20	156570	ADVU-80-20-P-A	156656	ADVU-80-20-A-P-A
	25	156571	ADVU-80-25-P-A	156657	ADVU-80-25-A-P-A
	30	156572	ADVU-80-30-P-A	156658	ADVU-80-30-A-P-A
	40	156573	ADVU-80-40-P-A	156659	ADVU-80-40-A-P-A
	50	156574	ADVU-80-50-P-A	156660	ADVU-80-50-A-P-A
	60	156575	ADVU-80-60-P-A	156661	ADVU-80-60-A-P-A
		80	156576	ADVU-80-80-P-A	156662
100	10	156577	ADVU-100-10-P-A	156663	ADVU-100-10-A-P-A
	15	156578	ADVU-100-15-P-A	156664	ADVU-100-15-A-P-A
	20	156579	ADVU-100-20-P-A	156665	ADVU-100-20-A-P-A
	25	156580	ADVU-100-25-P-A	156666	ADVU-100-25-A-P-A
	30	156581	ADVU-100-30-P-A	156667	ADVU-100-30-A-P-A
	40	156582	ADVU-100-40-P-A	156668	ADVU-100-40-A-P-A
	50	156583	ADVU-100-50-P-A	156669	ADVU-100-50-A-P-A
	60	156584	ADVU-100-60-P-A	156670	ADVU-100-60-A-P-A
		80	156585	ADVU-100-80-P-A	156671

Data sheet – Double-acting, basic version

Ordering data – Basic version					
Piston ø [mm]	Stroke [mm]	Piston rod with female thread		Piston rod with male thread	
		Part no.	Type	Part no.	Type
125	10	175750	ADVU-125-10-P-A	175762	ADVU-125-10-A-P-A
	15	175751	ADVU-125-15-P-A	175763	ADVU-125-15-A-P-A
	20	175752	ADVU-125-20-P-A	175764	ADVU-125-20-A-P-A
	25	175753	ADVU-125-25-P-A	175765	ADVU-125-25-A-P-A
	30	175754	ADVU-125-30-P-A	175766	ADVU-125-30-A-P-A
	40	175755	ADVU-125-40-P-A	175767	ADVU-125-40-A-P-A
	50	175756	ADVU-125-50-P-A	175768	ADVU-125-50-A-P-A
	60	175757	ADVU-125-60-P-A	175769	ADVU-125-60-A-P-A
	80	175758	ADVU-125-80-P-A	175770	ADVU-125-80-A-P-A

Data sheet – Double-acting, basic version

Ordering data – Variants					
Piston Ø [mm]	Stroke [mm]	Piston rod with female thread		Piston rod with male thread	
		Part no.	Type	Part no.	Type
Variable stroke					
12	1 ... 200	156000	ADVU-12-...-P-A	156040	ADVU-12-...-A-P-A
16	1 ... 200	156001	ADVU-16-...-P-A	156041	ADVU-16-...-A-P-A
20	1 ... 200	156002	ADVU-20-...-P-A	156042	ADVU-20-...-A-P-A
25	1 ... 200	156003	ADVU-25-...-P-A	156043	ADVU-25-...-A-P-A
32	1 ... 300	156004	ADVU-32-...-P-A	156044	ADVU-32-...-A-P-A
40	1 ... 300	156005	ADVU-40-...-P-A	156045	ADVU-40-...-A-P-A
50	1 ... 300	156006	ADVU-50-...-P-A	156046	ADVU-50-...-A-P-A
63	1 ... 300	156007	ADVU-63-...-P-A	156047	ADVU-63-...-A-P-A
80	1 ... 400	156008	ADVU-80-...-P-A	156048	ADVU-80-...-A-P-A
100	1 ... 400	156009	ADVU-100-...-P-A	156049	ADVU-100-...-A-P-A
125	1 ... 400	175759	ADVU-125-...-P-A	175771	ADVU-125-...-A-P-A
S2 – Through piston rod					
12	1 ... 200	156010	ADVU-12-...-P-A-S2	156050	ADVU-12-...-A-P-A-S2
16	1 ... 200	156011	ADVU-16-...-P-A-S2	156051	ADVU-16-...-A-P-A-S2
20	1 ... 200	156012	ADVU-20-...-P-A-S2	156052	ADVU-20-...-A-P-A-S2
25	1 ... 200	156013	ADVU-25-...-P-A-S2	156053	ADVU-25-...-A-P-A-S2
32	1 ... 300	156014	ADVU-32-...-P-A-S2	156054	ADVU-32-...-A-P-A-S2
40	1 ... 300	156015	ADVU-40-...-P-A-S2	156055	ADVU-40-...-A-P-A-S2
50	1 ... 300	156016	ADVU-50-...-P-A-S2	156056	ADVU-50-...-A-P-A-S2
63	1 ... 300	156017	ADVU-63-...-P-A-S2	156057	ADVU-63-...-A-P-A-S2
80	1 ... 400	156018	ADVU-80-...-P-A-S2	156058	ADVU-80-...-A-P-A-S2
100	1 ... 400	156019	ADVU-100-...-P-A-S2	156059	ADVU-100-...-A-P-A-S2
125	1 ... 400	175760	ADVU-125-...-P-A-S2	175772	ADVU-125-...-A-P-A-S2
S6 – Heat-resistant up to 120°C					
12	1 ... 200	156030	ADVU-12-...-P-A-S6	156090	ADVU-12-...-A-P-A-S6
16	1 ... 200	156031	ADVU-16-...-P-A-S6	156091	ADVU-16-...-A-P-A-S6
20	1 ... 200	156032	ADVU-20-...-P-A-S6	156092	ADVU-20-...-A-P-A-S6
25	1 ... 200	156033	ADVU-25-...-P-A-S6	156093	ADVU-25-...-A-P-A-S6
32	1 ... 300	156034	ADVU-32-...-P-A-S6	156094	ADVU-32-...-A-P-A-S6
40	1 ... 300	156035	ADVU-40-...-P-A-S6	156095	ADVU-40-...-A-P-A-S6
50	1 ... 300	156036	ADVU-50-...-P-A-S6	156096	ADVU-50-...-A-P-A-S6
63	1 ... 300	156037	ADVU-63-...-P-A-S6	156097	ADVU-63-...-A-P-A-S6
80	1 ... 400	156038	ADVU-80-...-P-A-S6	156098	ADVU-80-...-A-P-A-S6
100	1 ... 400	156039	ADVU-100-...-P-A-S6	156099	ADVU-100-...-A-P-A-S6
125	1 ... 400	175761	ADVU-125-...-P-A-S6	175773	ADVU-125-...-A-P-A-S6
S26 – Through piston rod, heat resistant up to 120°C					
12	1 ... 200	156020	ADVU-12-...-P-A-S26	156080	ADVU-12-...-A-P-A-S26
16	1 ... 200	156021	ADVU-16-...-P-A-S26	156081	ADVU-16-...-A-P-A-S26
20	1 ... 200	156022	ADVU-20-...-P-A-S26	156082	ADVU-20-...-A-P-A-S26
25	1 ... 200	156023	ADVU-25-...-P-A-S26	156083	ADVU-25-...-A-P-A-S26
32	1 ... 300	156024	ADVU-32-...-P-A-S26	156084	ADVU-32-...-A-P-A-S26
40	1 ... 300	156025	ADVU-40-...-P-A-S26	156085	ADVU-40-...-A-P-A-S26
50	1 ... 300	156026	ADVU-50-...-P-A-S26	156086	ADVU-50-...-A-P-A-S26
63	1 ... 300	156027	ADVU-63-...-P-A-S26	156087	ADVU-63-...-A-P-A-S26
80	1 ... 400	156028	ADVU-80-...-P-A-S26	156088	ADVU-80-...-A-P-A-S26
100	1 ... 400	156029	ADVU-100-...-P-A-S26	156089	ADVU-100-...-A-P-A-S26

Data sheet – Double-acting, basic version

Ordering data – Variants					
Piston ø [mm]	Stroke [mm]	Piston rod with female thread		Piston rod with male thread	
		Part no.	Type	Part no.	Type
S20 – Through, hollow piston rod					
12	1 ... 200	–		156060	ADVU-12-...-A-P-A-S20
16	1 ... 200			156061	ADVU-16-...-A-P-A-S20
20	1 ... 200			156062	ADVU-20-...-A-P-A-S20
25	1 ... 200			156063	ADVU-25-...-A-P-A-S20
32	1 ... 300			156064	ADVU-32-...-A-P-A-S20
40	1 ... 300			156065	ADVU-40-...-A-P-A-S20
50	1 ... 300			156066	ADVU-50-...-A-P-A-S20
63	1 ... 300			156067	ADVU-63-...-A-P-A-S20
80	1 ... 400			156068	ADVU-80-...-A-P-A-S20
100	1 ... 400			156069	ADVU-100-...-A-P-A-S20
S206 – Through, hollow piston rod, heat resistant up to 120°C					
12	1 ... 200	–		156070	ADVU-12-...-A-P-A-S206
16	1 ... 200			156071	ADVU-16-...-A-P-A-S206
20	1 ... 200			156072	ADVU-20-...-A-P-A-S206
25	1 ... 200			156073	ADVU-25-...-A-P-A-S206
32	1 ... 300			156074	ADVU-32-...-A-P-A-S206
40	1 ... 300			156075	ADVU-40-...-A-P-A-S206
50	1 ... 300			156076	ADVU-50-...-A-P-A-S206
63	1 ... 300			156077	ADVU-63-...-A-P-A-S206
80	1 ... 400			156078	ADVU-80-...-A-P-A-S206
100	1 ... 400			156079	ADVU-100-...-A-P-A-S206
R3 – Increased corrosion protection					
12	1 ... 200	176840	ADVU-12-...-P-A-R3	176851	ADVU-12-...-A-P-A-R3
16	1 ... 200	176841	ADVU-16-...-P-A-R3	176852	ADVU-16-...-A-P-A-R3
20	1 ... 200	176842	ADVU-20-...-P-A-R3	176853	ADVU-20-...-A-P-A-R3
25	1 ... 200	176843	ADVU-25-...-P-A-R3	176854	ADVU-25-...-A-P-A-R3
32	1 ... 300	176844	ADVU-32-...-P-A-R3	176855	ADVU-32-...-A-P-A-R3
40	1 ... 300	176845	ADVU-40-...-P-A-R3	176856	ADVU-40-...-A-P-A-R3
50	1 ... 300	176846	ADVU-50-...-P-A-R3	176857	ADVU-50-...-A-P-A-R3
63	1 ... 300	176847	ADVU-63-...-P-A-R3	176858	ADVU-63-...-A-P-A-R3
80	1 ... 400	176848	ADVU-80-...-P-A-R3	176859	ADVU-80-...-A-P-A-R3
100	1 ... 400	176849	ADVU-100-...-P-A-R3	176860	ADVU-100-...-A-P-A-R3
125	1 ... 400	176850	ADVU-125-...-P-A-R3	176861	ADVU-125-...-A-P-A-R3

Data sheet – Double-acting, basic version

Ordering data – Sets of wearing parts				
	Part no.	Type	Part no.	Type
Piston ø	Basic version		S6 – Heat-resistant up to 120°C	
32	121119	ADVU-32-...-(A)-P-A ¹⁾	383563	ADVU-32-...-(A)-P-A-S6 ¹⁾
40	121120	ADVU-40-...-(A)-P-A ¹⁾	383564	ADVU-40-...-(A)-P-A-S6 ¹⁾
50	121121	ADVU-50-...-(A)-P-A ¹⁾	383565	ADVU-50-...-(A)-P-A-S6 ¹⁾
63	121122	ADVU-63-...-(A)-P-A ¹⁾	383566	ADVU-63-...-(A)-P-A-S6 ¹⁾
80	121123	ADVU-80-...-(A)-P-A ¹⁾	383567	ADVU-80-...-(A)-P-A-S6 ¹⁾
100	121124	ADVU-100-...-(A)-P-A ¹⁾	383568	ADVU-100-...-(A)-P-A-S6 ¹⁾
125	380423	ADVU-125-...-(A)-P-A ¹⁾	383569	ADVU-125-...-(A)-P-A-S6 ¹⁾

1) Mounting grease included in the scope of delivery

2) Mounting grease not included in scope of delivery. If required, please order separately using part no. 329 555 (20 ml)

Data sheet – Double-acting, protected against rotation with square piston rod

Function

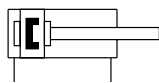

- Diameter
12 ... 100 mm

- Stroke length
1 ... 400 mm

- www.festo.com

Variants

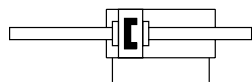

S2

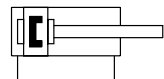

S6

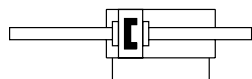

S26

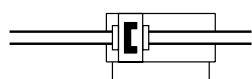

S20

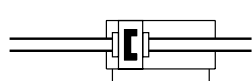

S206



ADVULQ-...-P-A



ADVULQ-...-P-A-S2

General technical data

Piston \varnothing	12	16	20	25	32	40	50	63	80	100
Pneumatic connection	M5	M5	M5	M5	G1/8	G1/8	G1/8	G1/8	G1/8	G1/4
Piston rod end	Female thread	M3	M4	M5	M5	M6	M6	M8	M8	M10
	Male thread	M6	M8	M10x1.25				M12x1.25		M16x1.5
Operating medium	Compressed air to ISO 8573-1:2010 [7:4:4]									
Note on the operating/ pilot medium	Lubricated operation possible (in which case lubricated operation will always be required)									
Design	Piston									
	Piston rod									
Cushioning	Elastic cushioning rings/pads at both ends									
Position sensing	Via proximity switch									
Type of mounting	Via through-hole									
	With female thread									
	With accessories									
Mounting position	Any									

- Note

This product conforms to ISO 1179-1 and ISO 228-1

Operating pressure [bar]

Piston \varnothing	12	16	20	25	32	40	50	63	80	100
Piston rod at one end	1.3 ... 10		1.0 ... 10		0.8 ... 10			0.6 ... 10		
Through piston rod S2/S20	1.5 ... 10	1.3 ... 10	1.2 ... 10		1.0 ... 10			0.8 ... 10		

Environmental conditions

Compact cylinder	Basic version	S6
Ambient temperature ¹⁾ [°C]	-20 ... +80	0 ... +120
Corrosion resistance class CRC ²⁾	2	2

1) Note operating range of proximity switches

2) Corrosion resistance class CRC 2 to Festo standard FN 940070

Moderate corrosion stress. Indoor applications in which condensation can occur. External visible parts with primarily decorative surface requirements which are in direct contact with a normal industrial environment.

Data sheet – Double-acting, protected against rotation with square piston rod

Forces [N] and impact energy [J]										
Piston \varnothing	12	16	20	25	32	40	50	63	80	100
Theoretical force at 6 bar, advancing	68	121	188	295	483	754	1178	1870	3016	4712
<i>S2/S20</i>	51	90	141	247	415	686	1057	1750	2827	4418
Theoretical force at 6 bar, retracting	51	90	141	247	415	686	1057	1750	2827	4418
<i>S2/S20</i>	51	90	141	247	415	686	1057	1750	2827	4418
Max. impact energy at the end positions	0.07	0.10	0.14	0.30	0.40	0.52	0.64	0.70	0.75	1.00
<i>S20</i>	0.01	0.01	0.01	0.01	0.04	0.05	0.06	0.07	0.08	0.10

Data sheet – Square piston rod										
Piston \varnothing	12	16	20	25	32	40	50	63	80	100
Max. torque at the piston rod ¹⁾ [Nm]	0.10	0.20	0.45	0.45	0.80	0.80	1.10	1.10	1.50	3.00
Max. torsional backlash of piston rod [°]	±1.0	±0.9	±0.8	±0.8	±0.6	±0.6	±0.5	±0.5	±0.4	±0.4
Piston rod distortion [°/50 mm]	0.40	0.30	0.25	0.25	0.20	0.20	0.15	0.15	0.15	0.09

1) The max. torque must not be exceeded even when attaching mounting components to the piston rod

Max. lateral force F_q as a function of the projection x

Piston rod at one end

Through piston rod

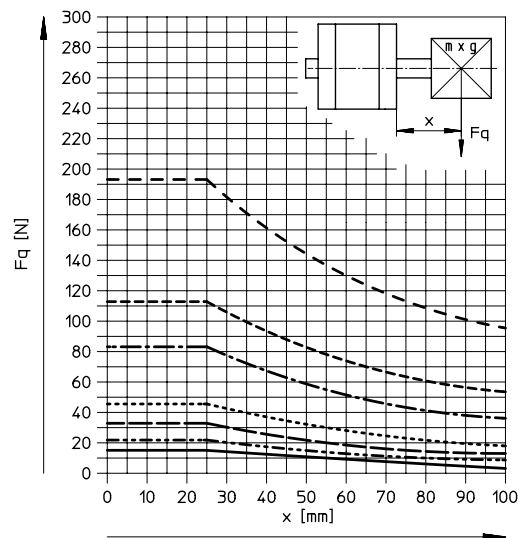
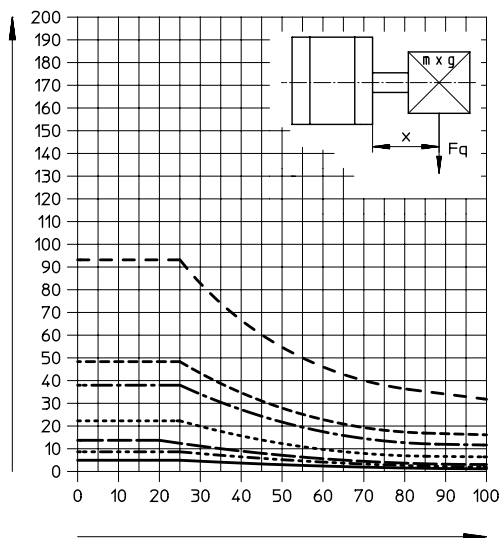

- $\varnothing 12$
- · - · $\varnothing 16$
- - - $\varnothing 20/25$
- · · · · $\varnothing 32/40$
- · - · - $\varnothing 50/63$
- - - - $\varnothing 80$
- - - - $\varnothing 100$

- $\varnothing 12$
- · - · $\varnothing 16$
- - - $\varnothing 20/25$
- · · · · $\varnothing 32/40$
- · - · - $\varnothing 50/63$
- - - - $\varnothing 80$
- - - - $\varnothing 100$

Data sheet – Double-acting, protected against rotation with square piston rod

Max. lateral load F_q as a function of projection x and lever arm a

Q – Square piston rod

$\varnothing 12$

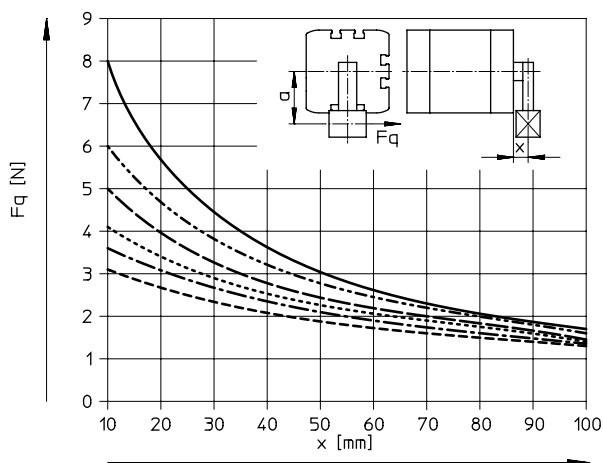

- a = 5 mm
- - - a = 10 mm
- - - a = 15 mm
- a = 20 mm
- · - · a = 25 mm
- - - a = 30 mm

Through piston rod

$\varnothing 16$

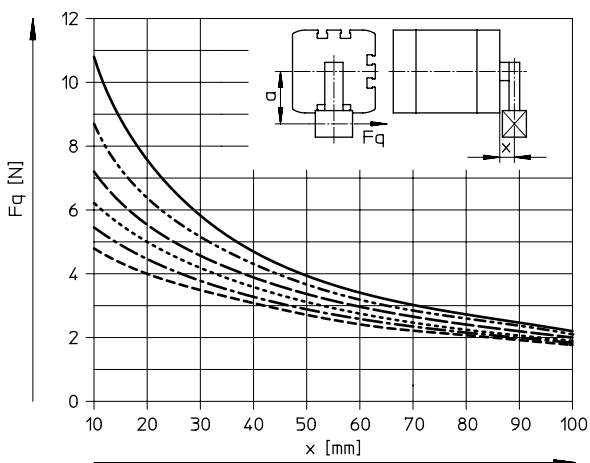

- a = 5 mm
- - - a = 10 mm
- - - a = 15 mm
- a = 20 mm
- · - · a = 25 mm
- - - a = 30 mm

$\varnothing 20/25$

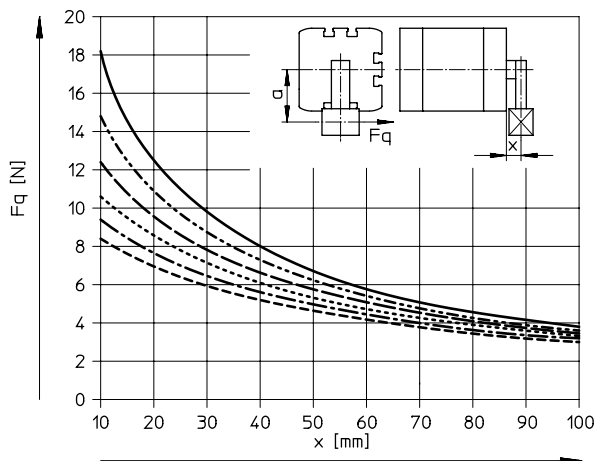

- a = 5 mm
- - - a = 10 mm
- - - a = 15 mm
- a = 20 mm
- · - · a = 25 mm
- - - a = 30 mm

$\varnothing 32/40$

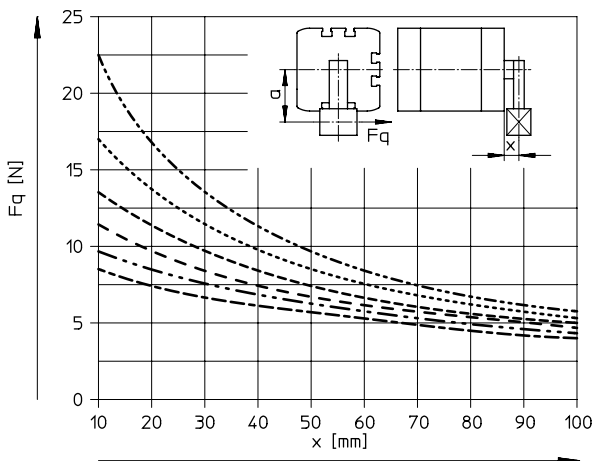

- - - a = 10 mm
- a = 20 mm
- - - a = 30 mm
- - - a = 40 mm
- · - · a = 50 mm
- - - a = 60 mm

Data sheet – Double-acting, protected against rotation with square piston rod

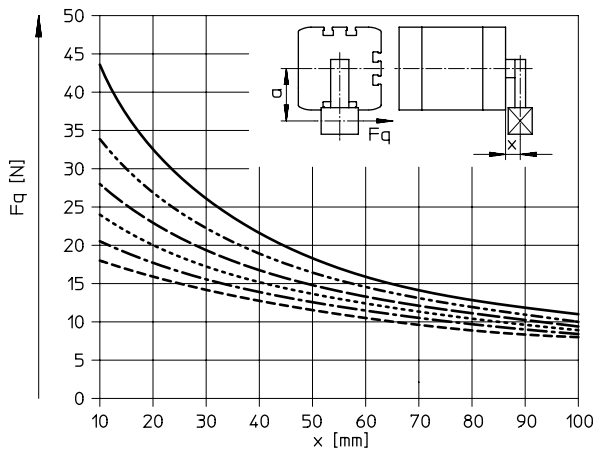
Max. lateral load F_q as a function of projection x and lever arm a $\varnothing 50/63$ $\varnothing 80/100$ 

- a = 10 mm
- · - · - a = 20 mm
- - - a = 30 mm
- · · · · a = 40 mm
- · - · - a = 50 mm
- - - a = 60 mm

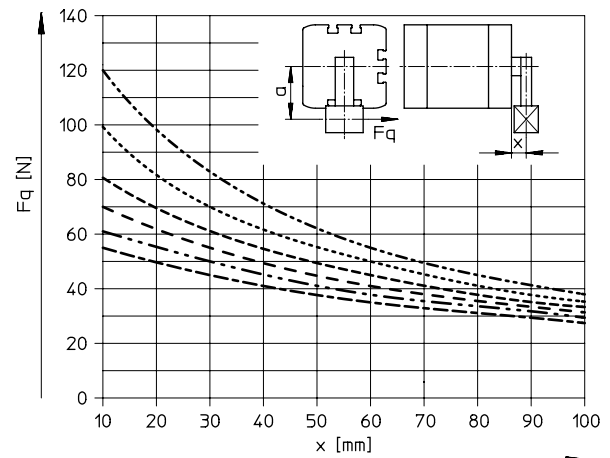

- · - · - a = 10 mm
- · · · · a = 20 mm
- - - a = 30 mm
- · - · - a = 40 mm
- · - · - a = 50 mm
- · - · - a = 60 mm

Weight [g]										
Piston \varnothing	12	16	20	25	32	40	50	63	80	100
Product weight with 0 mm stroke	87	89	149	180	300	433	560	1059	1772	2797
Additional weight per 10 mm stroke	15	15	23	28	40	59	72	107	168	177
Moving mass with 0 mm stroke	8	12	20	26	49	63	112	134	307	614
Additional mass per 10 mm stroke	2	4	6	6	9	9	16	16	25	38

Data sheet – Double-acting, protected against rotation with square piston rod

Materials

Sectional view

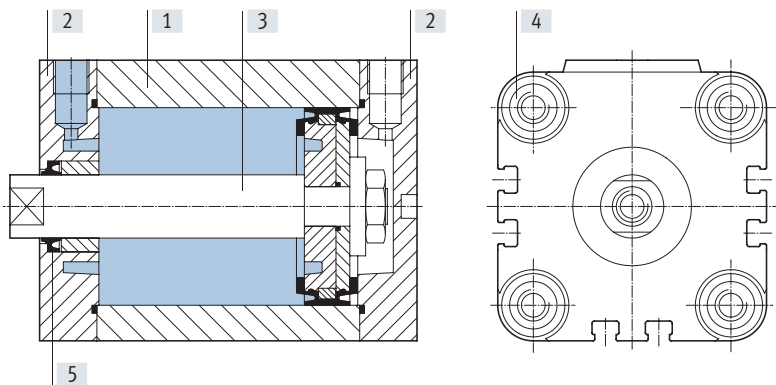

Compact cylinder		Basic version	S6
[1]	Cylinder barrel	Wrought aluminium alloy	Wrought aluminium alloy
[2]	Cover	Wrought aluminium alloy	Wrought aluminium alloy
[3]	Piston rod	∅ 12 ... 32	High-alloy stainless steel
		∅ 40 ... 100	High-alloy steel
[4]	Flange screws	∅ 12 ... 16	High-alloy stainless steel
		∅ 20 ... 100	Galvanised steel
[5]	Dynamic seals	Polyurethane	Fluoro rubber

Data sheet – Double-acting, protected against rotation with square piston rod

Dimensions – Basic cylinders

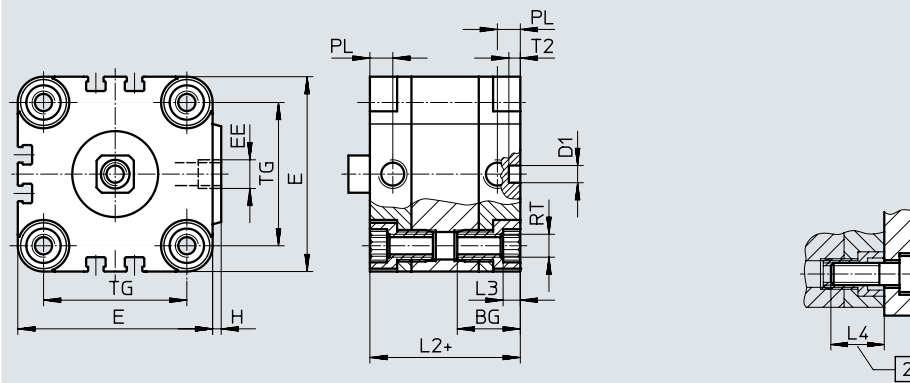
Download CAD data → www.festo.com-  - **Note**

To mount from above with piston diameter 12 and 16 mm, only use 2 diagonal screws or use non-magnetic screws.

+ = plus stroke length

[2] Minimum screw-in depth

∅	BG	D1 ∅ H9	E	EE	H	L2	L3	L4	PL	RT	T2	TG
[mm]											-0.2	
12	18.5	6	29	M5	1	38	3	16	8	M4	4	18
16	18.5	6	29	M5	1	38	3	16	8	M4	4	18
20	18.5	6	36	M5	1.5	38	4	18	8	M5	4	22
25	18.5	6	40	M5	1.5	39.5	4	18	8	M5	4	26
32	21.5	6	50	G1/8	2	44.5	5	20	8	M6	4	32
40	21.5	6	60	G1/8	2.5	45.5	5	20	8	M6	4	42
50	22	6	68	G1/8	3	45.5	6	20	8	M8	4	50
63	24.5	8	87	G1/8	4	50	8	25	8	M10	4	62
80	27.5	8	107	G1/8	4	56	8	25	8.5	M10	4	82
100	32.5	8	128	G1/4	5	66.5	8	25	10.5	M10	4	103

-  - **Note**

This product conforms to ISO 1179-1 and ISO 228-1

Data sheet – Double-acting, protected against rotation with square piston rod

Dimensions – Variants

Download CAD data → www.festo.com

Basic version

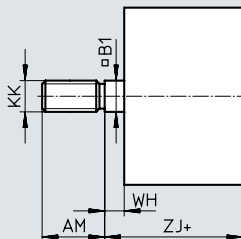
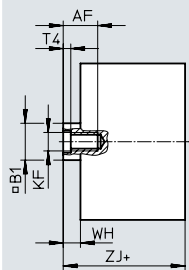

S2 – Through piston rod

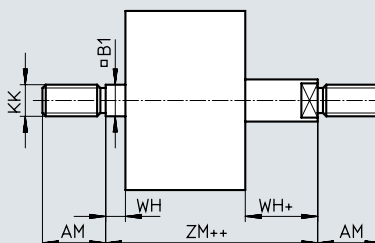
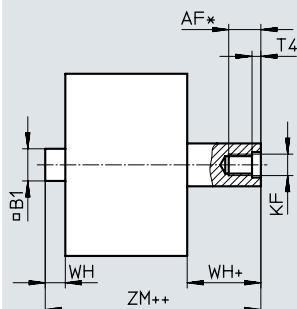

S20 – Through, hollow piston rod

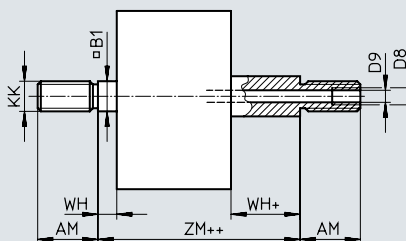

+ = plus stroke length

++ = plus 2x stroke length

∅ [mm]	AF	AM	B1 □	D8	D9 ∅	KF	KK	T4	WH	ZJ	ZM
12	8	16	5.5	–	2.3	M3	M6	1.5	4.5	42.5	47
16	10	20	7	–	3.2	M4	M8	1.5	4.5	42.5	47
20 ²⁾	12	22	9	–	3.8	M5	M10x1.25	2	4.5	42.5	47
25 ²⁾	12	22	9	–	3.8	M5	M10x1.25	2	5.5	45	50.5
32 ²⁾	14	22	10	–	4.5	M6	M10x1.25	2.6	6	50.5	56.5
40 ²⁾	14	22	10	–	4.5	M6	M10x1.25	2.6	6.5	52	58.5
50 ²⁾	16	24	12	–	6	M8	M12x1.25	3.3	7.5	53	60.5
63 ²⁾	16	24	12	–	6	M8	M12x1.25	3.3	7.5	57.5	65
80 ²⁾	20 ¹⁾	32	16	G1/8	8	M10	M16x1.5	4.7	8	64	72
100 ²⁾	24 ¹⁾	40	20	G1/4	11.7	M12	M20x1.5	6.1	10	76.5	86.5

1) With a stroke < 5 mm, the maximum screw-in depth is reduced by 5 mm

2) Nut for piston rod thread included in the scope of delivery

Data sheet – Double-acting, protected against rotation with square piston rod

Ordering data – Basic version					
Piston Ø [mm]	Stroke [mm]	Piston rod with female thread		Piston rod with male thread	
		Part no.	Type	Part no.	Type
12	5	156672	ADVULQ-12-5-P-A	156758	ADVULQ-12-5-A-P-A
	10	156673	ADVULQ-12-10-P-A	156759	ADVULQ-12-10-A-P-A
	15	156674	ADVULQ-12-15-P-A	156760	ADVULQ-12-15-A-P-A
	20	156675	ADVULQ-12-20-P-A	156761	ADVULQ-12-20-A-P-A
	25	156676	ADVULQ-12-25-P-A	156762	ADVULQ-12-25-A-P-A
	30	156677	ADVULQ-12-30-P-A	156763	ADVULQ-12-30-A-P-A
	40	156678	ADVULQ-12-40-P-A	156764	ADVULQ-12-40-A-P-A
16	5	156679	ADVULQ-16-5-P-A	156765	ADVULQ-16-5-A-P-A
	10	156680	ADVULQ-16-10-P-A	156766	ADVULQ-16-10-A-P-A
	15	156681	ADVULQ-16-15-P-A	156767	ADVULQ-16-15-A-P-A
	20	156682	ADVULQ-16-20-P-A	156768	ADVULQ-16-20-A-P-A
	25	156683	ADVULQ-16-25-P-A	156769	ADVULQ-16-25-A-P-A
	30	156684	ADVULQ-16-30-P-A	156770	ADVULQ-16-30-A-P-A
	40	156685	ADVULQ-16-40-P-A	156771	ADVULQ-16-40-A-P-A
20	5	156686	ADVULQ-20-5-P-A	156772	ADVULQ-20-5-A-P-A
	10	156687	ADVULQ-20-10-P-A	156773	ADVULQ-20-10-A-P-A
	15	156688	ADVULQ-20-15-P-A	156774	ADVULQ-20-15-A-P-A
	20	156689	ADVULQ-20-20-P-A	156775	ADVULQ-20-20-A-P-A
	25	156690	ADVULQ-20-25-P-A	156776	ADVULQ-20-25-A-P-A
	30	156691	ADVULQ-20-30-P-A	156777	ADVULQ-20-30-A-P-A
	40	156692	ADVULQ-20-40-P-A	156778	ADVULQ-20-40-A-P-A
	50	156693	ADVULQ-20-50-P-A	156779	ADVULQ-20-50-A-P-A
25	5	156694	ADVULQ-25-5-P-A	156780	ADVULQ-25-5-A-P-A
	10	156695	ADVULQ-25-10-P-A	156781	ADVULQ-25-10-A-P-A
	15	156696	ADVULQ-25-15-P-A	156782	ADVULQ-25-15-A-P-A
	20	156697	ADVULQ-25-20-P-A	156783	ADVULQ-25-20-A-P-A
	25	156698	ADVULQ-25-25-P-A	156784	ADVULQ-25-25-A-P-A
	30	156699	ADVULQ-25-30-P-A	156785	ADVULQ-25-30-A-P-A
	40	156700	ADVULQ-25-40-P-A	156786	ADVULQ-25-40-A-P-A
	50	156701	ADVULQ-25-50-P-A	156787	ADVULQ-25-50-A-P-A
32	5	156702	ADVULQ-32-5-P-A	156788	ADVULQ-32-5-A-P-A
	10	156703	ADVULQ-32-10-P-A	156789	ADVULQ-32-10-A-P-A
	15	156704	ADVULQ-32-15-P-A	156790	ADVULQ-32-15-A-P-A
	20	156705	ADVULQ-32-20-P-A	156791	ADVULQ-32-20-A-P-A
	25	156706	ADVULQ-32-25-P-A	156792	ADVULQ-32-25-A-P-A
	30	156707	ADVULQ-32-30-P-A	156793	ADVULQ-32-30-A-P-A
	40	156708	ADVULQ-32-40-P-A	156794	ADVULQ-32-40-A-P-A
	50	156709	ADVULQ-32-50-P-A	156795	ADVULQ-32-50-A-P-A
	60	156710	ADVULQ-32-60-P-A	156796	ADVULQ-32-60-A-P-A
	80	156711	ADVULQ-32-80-P-A	156797	ADVULQ-32-80-A-P-A

Data sheet – Double-acting, protected against rotation with square piston rod

Ordering data – Basic version					
Piston ø [mm]	Stroke [mm]	Piston rod with female thread		Piston rod with male thread	
		Part no.	Type	Part no.	Type
40	5	156712	ADVULQ-40-5-P-A	156798	ADVULQ-40-5-A-P-A
	10	156713	ADVULQ-40-10-P-A	156799	ADVULQ-40-10-A-P-A
	15	156714	ADVULQ-40-15-P-A	156800	ADVULQ-40-15-A-P-A
	20	156715	ADVULQ-40-20-P-A	156801	ADVULQ-40-20-A-P-A
	25	156716	ADVULQ-40-25-P-A	156802	ADVULQ-40-25-A-P-A
	30	156717	ADVULQ-40-30-P-A	156803	ADVULQ-40-30-A-P-A
	40	156718	ADVULQ-40-40-P-A	156804	ADVULQ-40-40-A-P-A
	50	156719	ADVULQ-40-50-P-A	156805	ADVULQ-40-50-A-P-A
	60	156720	ADVULQ-40-60-P-A	156806	ADVULQ-40-60-A-P-A
	80	156721	ADVULQ-40-80-P-A	156807	ADVULQ-40-80-A-P-A
50	10	156722	ADVULQ-50-10-P-A	156808	ADVULQ-50-10-A-P-A
	15	156723	ADVULQ-50-15-P-A	156809	ADVULQ-50-15-A-P-A
	20	156724	ADVULQ-50-20-P-A	156810	ADVULQ-50-20-A-P-A
	25	156725	ADVULQ-50-25-P-A	156811	ADVULQ-50-25-A-P-A
	30	156726	ADVULQ-50-30-P-A	156812	ADVULQ-50-30-A-P-A
	40	156727	ADVULQ-50-40-P-A	156813	ADVULQ-50-40-A-P-A
	50	156728	ADVULQ-50-50-P-A	156814	ADVULQ-50-50-A-P-A
	60	156729	ADVULQ-50-60-P-A	156815	ADVULQ-50-60-A-P-A
		80	156730	ADVULQ-50-80-P-A	156816
63	10	156731	ADVULQ-63-10-P-A	156 817	ADVULQ-63-10-A-P-A
	15	156732	ADVULQ-63-15-P-A	156 818	ADVULQ-63-15-A-P-A
	20	156733	ADVULQ-63-20-P-A	156 819	ADVULQ-63-20-A-P-A
	25	156734	ADVULQ-63-25-P-A	156 820	ADVULQ-63-25-A-P-A
	30	156735	ADVULQ-63-30-P-A	156 821	ADVULQ-63-30-A-P-A
	40	156736	ADVULQ-63-40-P-A	156 822	ADVULQ-63-40-A-P-A
	50	156737	ADVULQ-63-50-P-A	156 823	ADVULQ-63-50-A-P-A
	60	156738	ADVULQ-63-60-P-A	156 824	ADVULQ-63-60-A-P-A
		80	156739	ADVULQ-63-80-P-A	156 825
80	10	156740	ADVULQ-80-10-P-A	156826	ADVULQ-80-10-A-P-A
	15	156741	ADVULQ-80-15-P-A	156827	ADVULQ-80-15-A-P-A
	20	156742	ADVULQ-80-20-P-A	156828	ADVULQ-80-20-A-P-A
	25	156743	ADVULQ-80-25-P-A	156829	ADVULQ-80-25-A-P-A
	30	156744	ADVULQ-80-30-P-A	156830	ADVULQ-80-30-A-P-A
	40	156745	ADVULQ-80-40-P-A	156831	ADVULQ-80-40-A-P-A
	50	156746	ADVULQ-80-50-P-A	156832	ADVULQ-80-50-A-P-A
	60	156747	ADVULQ-80-60-P-A	156833	ADVULQ-80-60-A-P-A
		80	156748	ADVULQ-80-80-P-A	156834
100	10	156749	ADVULQ-100-10-P-A	156835	ADVULQ-100-10-A-P-A
	15	156750	ADVULQ-100-15-P-A	156836	ADVULQ-100-15-A-P-A
	20	156751	ADVULQ-100-20-P-A	156837	ADVULQ-100-20-A-P-A
	25	156752	ADVULQ-100-25-P-A	156838	ADVULQ-100-25-A-P-A
	30	156753	ADVULQ-100-30-P-A	156839	ADVULQ-100-30-A-P-A
	40	156754	ADVULQ-100-40-P-A	156840	ADVULQ-100-40-A-P-A
	50	156755	ADVULQ-100-50-P-A	156841	ADVULQ-100-50-A-P-A
	60	156756	ADVULQ-100-60-P-A	156842	ADVULQ-100-60-A-P-A
		80	156757	ADVULQ-100-80-P-A	156843

Data sheet – Double-acting, protected against rotation with square piston rod

Ordering data – Basic version					
Piston Ø [mm]	Stroke [mm]	Piston rod with female thread		Piston rod with male thread	
		Part no.	Type	Part no.	Type
12	1 ... 200	156100	ADVULQ-12-...-P-A	156140	ADVULQ-12-...-A-P-A
16	1 ... 200	156101	ADVULQ-16-...-P-A	156141	ADVULQ-16-...-A-P-A
20	1 ... 200	156102	ADVULQ-20-...-P-A	156142	ADVULQ-20-...-A-P-A
25	1 ... 200	156103	ADVULQ-25-...-P-A	156143	ADVULQ-25-...-A-P-A
32	1 ... 300	156104	ADVULQ-32-...-P-A	156144	ADVULQ-32-...-A-P-A
40	1 ... 300	156105	ADVULQ-40-...-P-A	156145	ADVULQ-40-...-A-P-A
50	1 ... 300	156106	ADVULQ-50-...-P-A	156146	ADVULQ-50-...-A-P-A
63	1 ... 300	156107	ADVULQ-63-...-P-A	156147	ADVULQ-63-...-A-P-A
80	1 ... 400	156108	ADVULQ-80-...-P-A	156148	ADVULQ-80-...-A-P-A
100	1 ... 400	156109	ADVULQ-100-...-P-A	156149	ADVULQ-100-...-A-P-A
12	1 ... 200	156110	ADVULQ-12-...-P-A-S2	156150	ADVULQ-12-...-A-P-A-S2
16	1 ... 200	156111	ADVULQ-16-...-P-A-S2	156151	ADVULQ-16-...-A-P-A-S2
20	1 ... 200	156112	ADVULQ-20-...-P-A-S2	156152	ADVULQ-20-...-A-P-A-S2
25	1 ... 200	156113	ADVULQ-25-...-P-A-S2	156153	ADVULQ-25-...-A-P-A-S2
32	1 ... 300	156114	ADVULQ-32-...-P-A-S2	156154	ADVULQ-32-...-A-P-A-S2
40	1 ... 300	156115	ADVULQ-40-...-P-A-S2	156155	ADVULQ-40-...-A-P-A-S2
50	1 ... 300	156116	ADVULQ-50-...-P-A-S2	156156	ADVULQ-50-...-A-P-A-S2
63	1 ... 300	156117	ADVULQ-63-...-P-A-S2	156157	ADVULQ-63-...-A-P-A-S2
80	1 ... 400	156118	ADVULQ-80-...-P-A-S2	156158	ADVULQ-80-...-A-P-A-S2
100	1 ... 400	156119	ADVULQ-100-...-P-A-S2	156159	ADVULQ-100-...-A-P-A-S2
12	1 ... 200	156130	ADVULQ-12-...-P-A-S6	156190	ADVULQ-12-...-A-P-A-S6
16	1 ... 200	156131	ADVULQ-16-...-P-A-S6	156191	ADVULQ-16-...-A-P-A-S6
20	1 ... 200	156132	ADVULQ-20-...-P-A-S6	156192	ADVULQ-20-...-A-P-A-S6
25	1 ... 200	156133	ADVULQ-25-...-P-A-S6	156193	ADVULQ-25-...-A-P-A-S6
32	1 ... 300	156134	ADVULQ-32-...-P-A-S6	156194	ADVULQ-32-...-A-P-A-S6
40	1 ... 300	156135	ADVULQ-40-...-P-A-S6	156195	ADVULQ-40-...-A-P-A-S6
50	1 ... 300	156136	ADVULQ-50-...-P-A-S6	156196	ADVULQ-50-...-A-P-A-S6
63	1 ... 300	156137	ADVULQ-63-...-P-A-S6	156197	ADVULQ-63-...-A-P-A-S6
80	1 ... 400	156138	ADVULQ-80-...-P-A-S6	156198	ADVULQ-80-...-A-P-A-S6
100	1 ... 400	156139	ADVULQ-100-...-P-A-S6	156199	ADVULQ-100-...-A-P-A-S6
12	1 ... 200	156120	ADVULQ-12-...-P-A-S26	156180	ADVULQ-12-...-A-P-A-S26
16	1 ... 200	156121	ADVULQ-16-...-P-A-S26	156181	ADVULQ-16-...-A-P-A-S26
20	1 ... 200	156122	ADVULQ-20-...-P-A-S26	156182	ADVULQ-20-...-A-P-A-S26
25	1 ... 200	156123	ADVULQ-25-...-P-A-S26	156183	ADVULQ-25-...-A-P-A-S26
32	1 ... 300	156124	ADVULQ-32-...-P-A-S26	156184	ADVULQ-32-...-A-P-A-S26
40	1 ... 300	156125	ADVULQ-40-...-P-A-S26	156185	ADVULQ-40-...-A-P-A-S26
50	1 ... 300	156126	ADVULQ-50-...-P-A-S26	156186	ADVULQ-50-...-A-P-A-S26
63	1 ... 300	156127	ADVULQ-63-...-P-A-S26	156187	ADVULQ-63-...-A-P-A-S26
80	1 ... 400	156128	ADVULQ-80-...-P-A-S26	156188	ADVULQ-80-...-A-P-A-S26
100	1 ... 400	156129	ADVULQ-100-...-P-A-S26	156189	ADVULQ-100-...-A-P-A-S26

Data sheet – Double-acting, protected against rotation with square piston rod

Ordering data – Variants							
Piston ø [mm]	Stroke [mm]	Piston rod with female thread		Piston rod with male thread			
		Part no.	Type	Part no.	Type		
S20 – Through, hollow piston rod							
16	1 ... 200	-		156161	ADVULQ-16-...-A-P-A-S20		
20	1 ... 200			156162	ADVULQ-20-...-A-P-A-S20		
25	1 ... 200			156163	ADVULQ-25-...-A-P-A-S20		
32	1 ... 300			156164	ADVULQ-32-...-A-P-A-S20		
40	1 ... 300			156165	ADVULQ-40-...-A-P-A-S20		
50	1 ... 300			156166	ADVULQ-50-...-A-P-A-S20		
63	1 ... 300			156167	ADVULQ-63-...-A-P-A-S20		
80	1 ... 400			156168	ADVULQ-80-...-A-P-A-S20		
100	1 ... 400			156169	ADVULQ-100-...-A-P-A-S20		
S206 – Through, hollow piston rod, heat resistant up to 120°C							
16	1 ... 200			-		156171	ADVULQ-16-...-A-P-A-S206
20	1 ... 200	156172	ADVULQ-20-...-A-P-A-S206				
25	1 ... 200	156173	ADVULQ-25-...-A-P-A-S206				
32	1 ... 300	156174	ADVULQ-32-...-A-P-A-S206				
40	1 ... 300	156175	ADVULQ-40-...-A-P-A-S206				
50	1 ... 300	156176	ADVULQ-50-...-A-P-A-S206				
63	1 ... 300	156177	ADVULQ-63-...-A-P-A-S206				
80	1 ... 400	156178	ADVULQ-80-...-A-P-A-S206				
100	1 ... 400	156179	ADVULQ-100-...-A-P-A-S206				

Data sheet – Double-acting, reinforced piston rod

Function

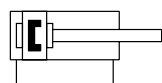

-  Diameter
25, 40, 63, 100 mm

-  Stroke length
1 ... 2000 mm

 www.festo.com



ADVU-...-P-A-S1

General technical data				
Piston \varnothing	25	40	63	100
Pneumatic connection	M5	M5	G1/8	G1/4
Piston rod end	Female thread	M5	M8	M10
Operating medium	Compressed air to ISO 8573-1:2010 [7:4:4]			
Note on the operating/ pilot medium	Lubricated operation possible (in which case lubricated operation will always be required)			
Design	Piston			
	Piston rod			
Cushioning	Elastic cushioning rings/pads at both ends			
Position sensing	Via proximity switch			
Type of mounting	Via through-hole			
	With female thread			
	With accessories			
Mounting position	Any			

-  **Note**
This product conforms to ISO 1179-1
and ISO 228-1

Operating conditions				
Piston \varnothing	25	40	63	100
Operating pressure	[bar]	0.8 ... 10	0.8 ... 10	0.6 ... 10
Ambient temperature	[°C]	-20 ... +80 (observe operating range of proximity switches)		
Corrosion resistance class CRC ¹⁾	2			

1) Corrosion resistance class CRC 2 to Festo standard FN 940070

Moderate corrosion stress. Indoor applications in which condensation can occur. External visible parts with primarily decorative surface requirements which are in direct contact with a normal industrial environment.

Forces [N] and impact energy [J]				
Piston \varnothing	25	40	63	100
Theoretical force at 6 bar, advancing	295	754	1870	4712
Theoretical force at 6 bar, retracting	247	633	1682	4418
Max. impact energy at the end positions	0.30	0.52	0.70	1.00

Data sheet – Double-acting, reinforced piston rod

Max. lateral force F_q as a function of the projection x

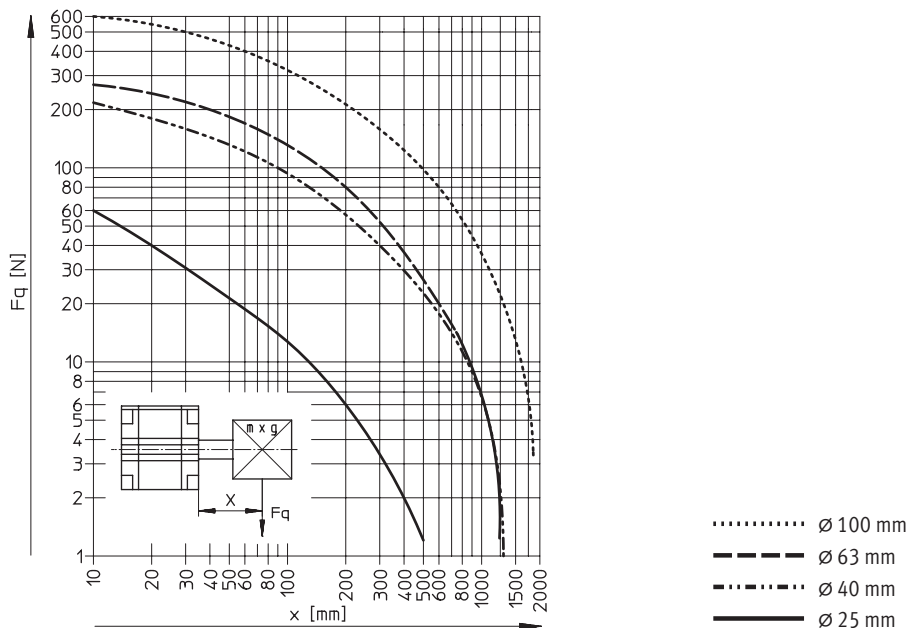

Weight [g]	25	40	63	100
Piston \varnothing	25	40	63	100
Product weight with 0 mm stroke	250	550	800	3500
Additional weight per 10 mm stroke	36	74	140	200
Moving mass with 0 mm stroke	26	63	134	614
Additional mass per 10 mm stroke	6	16	25	38

Materials

Sectional view

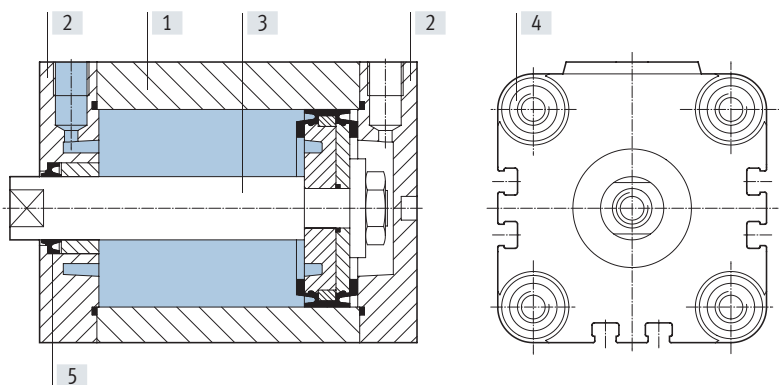

Compact cylinder		
[1]	Cylinder barrel	Wrought aluminium alloy
[2]	Cover	Wrought aluminium alloy
[3]	Piston rod	\varnothing 25 High-alloy stainless steel
		\varnothing 40, 63, 100 High-alloy steel
[4]	Flange screws	Galvanised steel
[5]	Dynamic seals	Polyurethane

Data sheet – Double-acting, reinforced piston rod

Dimensions – Basic cylinders

Download CAD data → www.festo.com

Piston \varnothing 25 mm

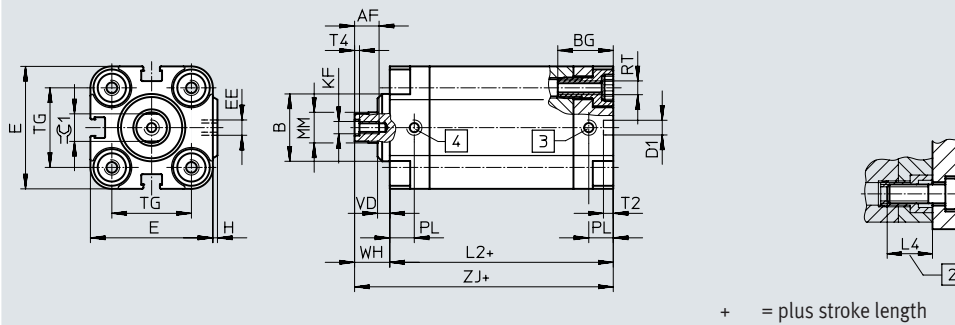

+ = plus stroke length

- [2] Minimum screw-in depth
- [3] Cylinder advancing
- [4] Cylinder retracting

Piston \varnothing 40, 63, 100 mm

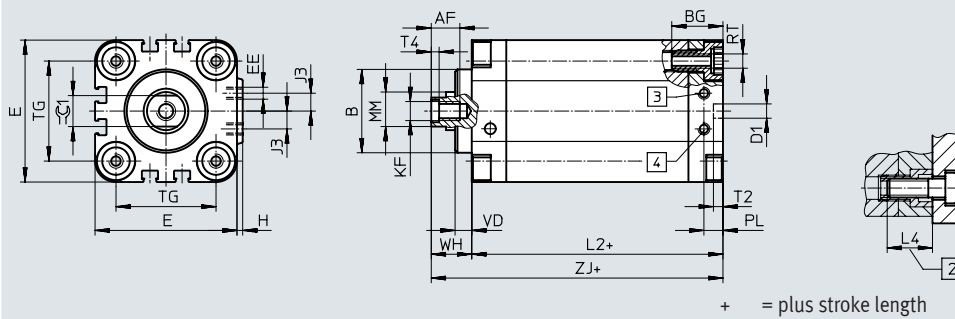

+ = plus stroke length

- [2] Minimum screw-in depth
- [3] Cylinder advancing
- [4] Cylinder retracting

\varnothing	AF	B \varnothing	BG	D1 \varnothing H9	E	EE	H	J3	KF	L2	L4
25	10	22	18.5	6	40	M5	1.5	–	M5	45.5	18
40	12	35	21.5	6	60	M5	2.5	7.5	M8	52.5	20
63	16	42	24.5	8	87	G1/8	4	10.5	M10	58	25
100	20	55	32.5	8	128	G1/4	5	14.5	M12	77.5	25

\varnothing	MM \varnothing	PL	RT	T2	T4	TG	VD	WH	ZJ	\approx G1
				-0.2						h13
25	10	8	M5	4	2	26	4	11.5	57	9
40	16	8	M6	4	3.3	42	7	16.5	69	13
63	20	8	M10	4	4.7	62	11.5	21.5	79.5	17
100	25	10.5	M10	4	6.1	103	15	27	104.5	22

- **Note**

This product conforms to ISO 1179-1 and ISO 228-1

Ordering data

Piston \varnothing [mm]	Stroke [mm]	Part no.	Type
25	1 ... 500	161155	ADVU-25-...P-A-S1
40	1 ... 2000	161156	ADVU-40-...P-A-S1
63	1 ... 2000	161157	ADVU-63-...P-A-S1
100	1 ... 2000	161158	ADVU-100-...P-A-S1

Data sheet – Single-acting, basic version

Function

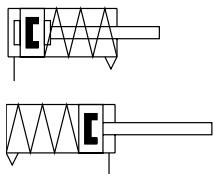

- - Diameter
12 ... 100 mm

- - Stroke length
1 ... 25 mm

- - www.festo.com
Sets of wearing parts
→ page 45

Variants

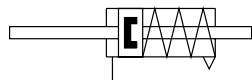

S2

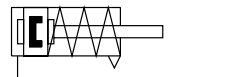

S6

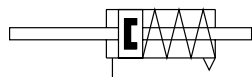

S26

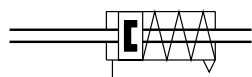

S20

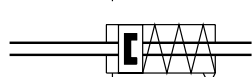

S206

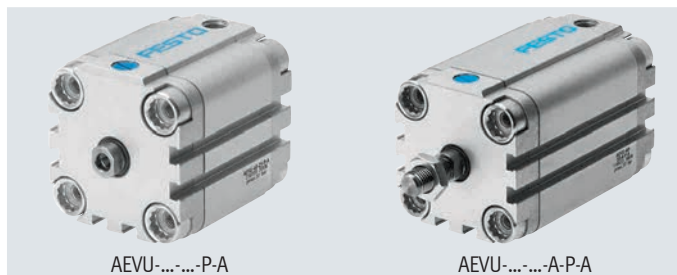

AEVU-...-...-P-A

AEVU-...-...-A-P-A



AEVU-...-...-P-A-S2

AEVU-...-...-A-P-A-S20

General technical data

Piston \varnothing	12	16	20	25	32	40	50	63	80	100
Pneumatic connection	M5	M5	M5	M5	G1/8	G1/8	G1/8	G1/8	G1/8	G1/4
Piston rod end	Female thread	M3	M4	M5	M5	M6	M6	M8	M8	M10
	Male thread	M6	M8	M10x1.25				M12x1.25		M16x1.5
Operating medium	Compressed air to ISO 8573-1:2010 [7:4:4]									
Note on the operating/ pilot medium	Lubricated operation possible (in which case lubricated operation will always be required)									
Design	Piston									
	Piston rod									
Cushioning	Elastic cushioning rings/pads at both ends									
Position sensing	Via proximity switch									
Type of mounting	Via through-hole									
	With female thread									
	With accessories									
Mounting position	Any									

Note

This product conforms to ISO 1179-1 and ISO 228-1

Operating pressure [bar]

Piston \varnothing	12	16	20	25	32	40	50	63	80	100
Pushing variant AEVU										
Piston rod at one end	1.5 ... 10	1.3 ... 10	1.0 ... 10		0.8 ... 10			0.6 ... 10		
Through piston rod S2/S20	1.7 ... 10	1.5 ... 10	1.4 ... 10	1.2 ... 10			1.0 ... 10			
Pulling variant AEVUZ										
Piston rod at one end	1.5 ... 10	1.3 ... 10	1.0 ... 10	0.8 ... 10						

Data sheet – Single-acting, basic version

Environmental conditions		Basic version	S6
Compact cylinder			
Ambient temperature ¹⁾	[°C]	-20 ... +80	0 ... +120
Corrosion resistance class CRC ²⁾		2	2

1) Note operating range of proximity switches

2) Corrosion resistance class 2 to Festo standard 940070

Components subject to moderate corrosion stress. External visible parts with primarily decorative surface requirements which are in direct contact with a normal industrial environment or media such as coolants or lubricating agents

Forces [N]										
Piston \varnothing	12	16	20	25	32	40	50	63	80	100
Pushing variant AEUU										
Theoretical force at 6 bar, advancing	59	111	171	269	450	704	1121	1799	2902	4516
$S2/S20$	42	81	123	221	382	636	999	1679	2733	4222
Pulling variant AEUU										
Theoretical force at 6 bar, advancing	42	81	123	221	382	636	999	1679	2733	4222

Spring return force F as a function of stroke l

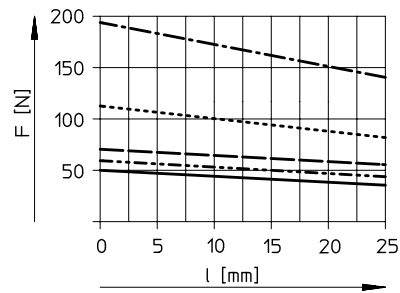
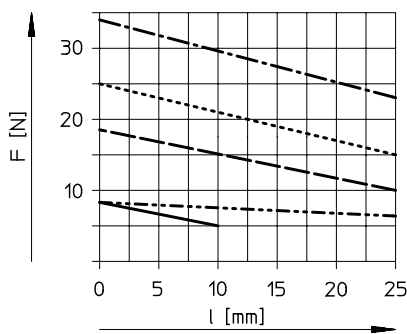

— AEU/AEUVZ-12
 - - - - - AEU/AEUVZ-16
 - - - - - AEU/AEUVZ-20
 ········ AEU/AEUVZ-25
 - · - · - AEU/AEUVZ-32

— AEU/AEUVZ-40
 - - - - - AEU/AEUVZ-50
 - - - - - AEU/AEUVZ-63
 ········ AEU/AEUVZ-80
 - · - · - AEU/AEUVZ-100

Weight [g]										
Piston \varnothing	12	16	20	25	32	40	50	63	80	100
Product weight with 0 mm stroke	87	89	149	180	300	433	560	1059	1772	2797
Additional weight per 10 mm stroke	15	15	23	28	40	59	72	107	168	177
Moving mass with 0 mm stroke	8	12	20	26	49	63	112	134	307	614
Additional mass per 10 mm stroke	2	4	6	6	9	9	16	16	25	38

Data sheet – Single-acting, basic version

Materials

Sectional view

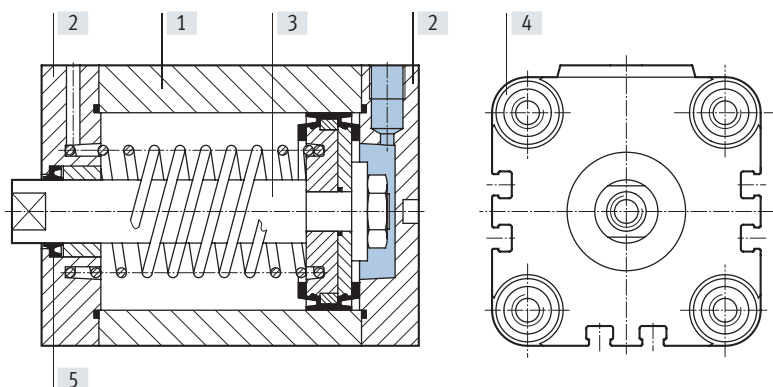

Compact cylinder	Basic version	S6
[1] Cylinder barrel	Wrought aluminium alloy	Wrought aluminium alloy
[2] Cover	Wrought aluminium alloy	Wrought aluminium alloy
[3] Piston rod	$\varnothing 12 \dots 32$ High-alloy stainless steel	High-alloy stainless steel
	$\varnothing 40 \dots 100$ High-alloy steel	High-alloy steel
[4] Flange screws	$\varnothing 12 \dots 16$ High-alloy stainless steel	High-alloy stainless steel
	$\varnothing 20 \dots 100$ Galvanised steel	Galvanised steel
[5] Dynamic seals	Polyurethane	Fluoro rubber

Dimensions – Basic cylinders

Download CAD data → www.festo.com

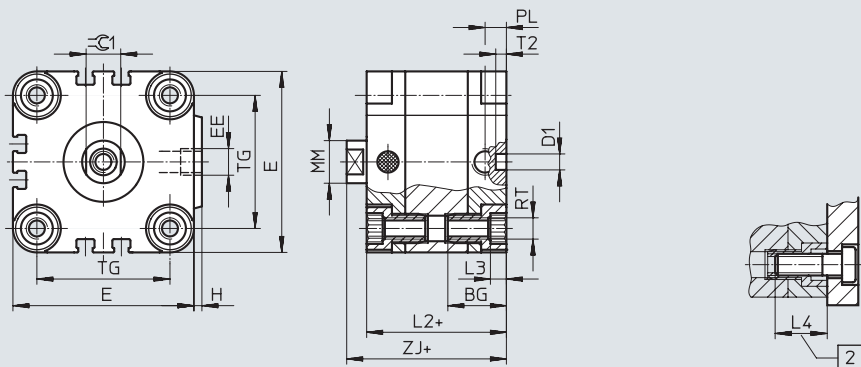

Note
To mount from above with piston diameter 12 and 16 mm, only use 2 diagonal screws or use non-magnetic screws.

+ = plus stroke length
[2] Minimum screw-in depth

\varnothing [mm]	BG	D1 \varnothing H9	E	EE	H	L2	L3	L4	MM \varnothing	PL	RT	T2	TG	ZJ	$\approx \varnothing 1$ h13
12	18.5	6	29	M5	1	38	3	16	6	8	M4	4	18	42.5	5
16	18.5	6	29	M5	1	38	3	16	8	8	M4	4	18	42.5	7
20	18.5	6	36	M5	1.5	38	4	18	10	8	M5	4	22	42.5	9
25	18.5	6	40	M5	1.5	39.5	4	18	10	8	M5	4	26	45	9
32	21.5	6	50	G1/8	2	44.5	5	20	12	8	M6	4	32	50.5	10
40	21.5	6	60	G1/8	2.5	45.5	5	20	12	8	M6	4	42	52	10
50	22	6	68	G1/8	3	45.5	6	20	16	8	M8	4	50	53	13
63	24.5	8	87	G1/8	4	50	8	25	16	8	M10	4	62	57.5	13
80	27.5	8	107	G1/8	4	56	8	25	20	8.5	M10	4	82	64	17
100	32.5	8	128	G1/4	5	66.5	8	25	25	10.5	M10	4	103	76.5	22

Note

This product conforms to ISO 1179-1 and ISO 228-1

Data sheet – Single-acting, basic version

Dimensions – Pushing variants AEUV

Download CAD data → www.festo.com

Basic version

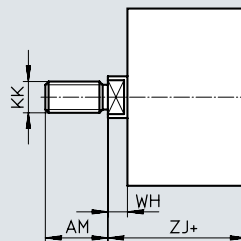
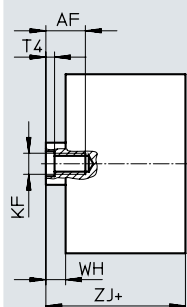

S2 – Through piston rod

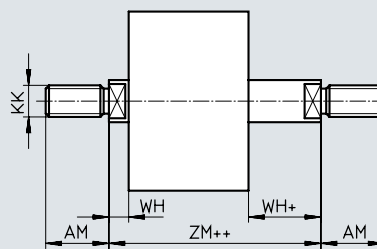
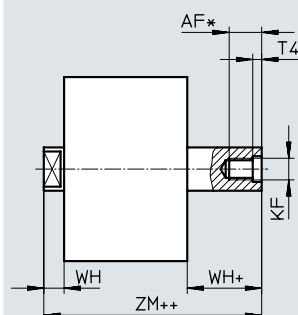

S20 – Through, hollow piston rod

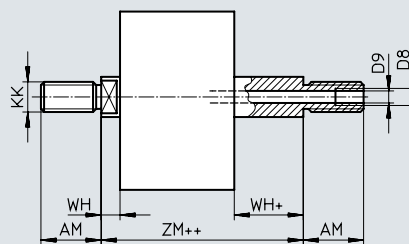

+ = plus stroke length
 ++ = plus 2x stroke length

∅ [mm]	AF	AM	D8	D9 ∅	KF	KK	T4	WH	ZJ	ZM
12	8	16	–	2.3	M3	M6	1.5	4.5	42.5	47
16	10	20	–	3.2	M4	M8	1.5	4.5	42.5	47
20 ²⁾	12	22	–	3.8	M5	M10x1.25	2	4.5	42.5	47
25 ²⁾	12	22	–	3.8	M5	M10x1.25	2	5.5	45	50.5
32 ²⁾	14	22	–	4.5	M6	M10x1.25	2.6	6	50.5	56.5
40 ²⁾	14	22	–	4.5	M6	M10x1.25	2.6	6.5	52	58.5
50 ²⁾	16	24	–	6	M8	M12x1.25	3.3	7.5	53	60.5
63 ²⁾	16	24	–	6	M8	M12x1.25	3.3	7.5	57.5	65
80 ²⁾	20 ¹⁾	32	G1/8	8	M10	M16x1.5	4.7	8	64	72
100 ²⁾	24 ¹⁾	40	G1/4	11.7	M12	M20x1.5	6.1	10	76.5	86.5

- 1) With a stroke < 5 mm, the maximum screw-in depth is reduced by 5 mm
 2) Nut for piston rod thread included in the scope of delivery

Data sheet – Single-acting, basic version

Dimensions – Pulling variants AEVUZ

Download CAD data → www.festo.com

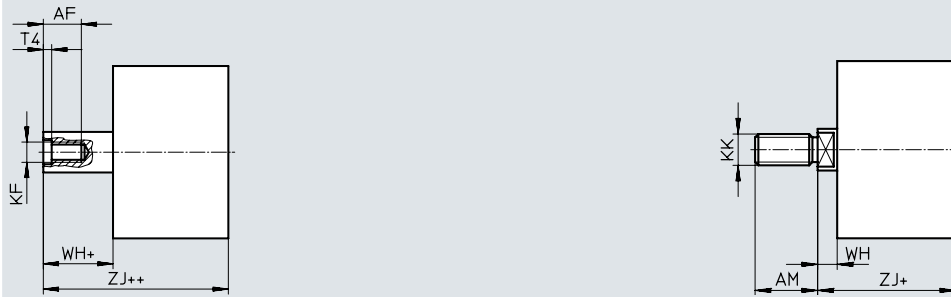

+ = plus stroke length
 ++ = plus 2x stroke length

∅ [mm]	AF	AM	KF	KK	T4	WH	ZJ
12	8	16	M3	M6	1.5	4.5	42.5
16	10	20	M4	M8	1.5	4.5	42.5
20 ¹⁾	12	22	M5	M10x1.25	2	4.5	42.5
25 ¹⁾	12	22	M5	M10x1.25	2	5.5	45
32 ¹⁾	14	22	M6	M10x1.25	2.6	6	50.5
40 ¹⁾	14	22	M6	M10x1.25	2.6	6.5	52
50 ¹⁾	16	24	M8	M12x1.25	3.3	7.5	53
63 ¹⁾	16	24	M8	M12x1.25	3.3	7.5	57.5
80 ¹⁾	20	32	M10	M16x1.5	4.7	8	64
100 ¹⁾	24	40	M12	M20x1.5	6.1	10	76.5

1) Nut for piston rod thread included in the scope of delivery

Data sheet – Single-acting, basic version

Ordering data – Pushing variants, basic version, AEVU					
Piston Ø [mm]	Stroke [mm]	Piston rod with female thread		Piston rod with male thread	
		Part no.	Type	Part no.	Type
12	5	156930	AEVU-12-5-P-A	156976	AEVU-12-5-A-P-A
	10	156931	AEVU-12-10-P-A	156977	AEVU-12-10-A-P-A
16	5	156935	AEVU-16-5-P-A	156981	AEVU-16-5-A-P-A
	10	156936	AEVU-16-10-P-A	156982	AEVU-16-10-A-P-A
	15	156937	AEVU-16-15-P-A	156983	AEVU-16-15-A-P-A
	20	156938	AEVU-16-20-P-A	156984	AEVU-16-20-A-P-A
	25	156939	AEVU-16-25-P-A	156985	AEVU-16-25-A-P-A
20	5	156940	AEVU-20-5-P-A	156986	AEVU-20-5-A-P-A
	10	156941	AEVU-20-10-P-A	156987	AEVU-20-10-A-P-A
	15	156942	AEVU-20-15-P-A	156988	AEVU-20-15-A-P-A
	20	156943	AEVU-20-20-P-A	156989	AEVU-20-20-A-P-A
	25	156944	AEVU-20-25-P-A	156990	AEVU-20-25-A-P-A
25	5	156945	AEVU-25-5-P-A	156991	AEVU-25-5-A-P-A
	10	156946	AEVU-25-10-P-A	156992	AEVU-25-10-A-P-A
	15	156947	AEVU-25-15-P-A	156993	AEVU-25-15-A-P-A
	20	156948	AEVU-25-20-P-A	156994	AEVU-25-20-A-P-A
	25	156949	AEVU-25-25-P-A	156995	AEVU-25-25-A-P-A
32	5	156950	AEVU-32-5-P-A	156996	AEVU-32-5-A-P-A
	10	156951	AEVU-32-10-P-A	156997	AEVU-32-10-A-P-A
	15	156952	AEVU-32-15-P-A	156998	AEVU-32-15-A-P-A
	20	156953	AEVU-32-20-P-A	156999	AEVU-32-20-A-P-A
	25	156954	AEVU-32-25-P-A	157000	AEVU-32-25-A-P-A
40	5	156955	AEVU-40-5-P-A	157001	AEVU-40-5-A-P-A
	10	156956	AEVU-40-10-P-A	157002	AEVU-40-10-A-P-A
	15	156957	AEVU-40-15-P-A	157003	AEVU-40-15-A-P-A
	20	156958	AEVU-40-20-P-A	157004	AEVU-40-20-A-P-A
	25	156959	AEVU-40-25-P-A	157005	AEVU-40-25-A-P-A
50	10	156960	AEVU-50-10-P-A	157006	AEVU-50-10-A-P-A
	15	156961	AEVU-50-15-P-A	157007	AEVU-50-15-A-P-A
	20	156962	AEVU-50-20-P-A	157008	AEVU-50-20-A-P-A
	25	156963	AEVU-50-25-P-A	157009	AEVU-50-25-A-P-A
63	10	156964	AEVU-63-10-P-A	157010	AEVU-63-10-A-P-A
	15	156965	AEVU-63-15-P-A	157011	AEVU-63-15-A-P-A
	20	156966	AEVU-63-20-P-A	157012	AEVU-63-20-A-P-A
	25	156967	AEVU-63-25-P-A	157013	AEVU-63-25-A-P-A
80	10	156968	AEVU-80-10-P-A	157014	AEVU-80-10-A-P-A
	15	156969	AEVU-80-15-P-A	157015	AEVU-80-15-A-P-A
	20	156970	AEVU-80-20-P-A	157016	AEVU-80-20-A-P-A
	25	156971	AEVU-80-25-P-A	157017	AEVU-80-25-A-P-A
100	10	156972	AEVU-100-10-P-A	157018	AEVU-100-10-A-P-A
	15	156973	AEVU-100-15-P-A	157019	AEVU-100-15-A-P-A
	20	156974	AEVU-100-20-P-A	157020	AEVU-100-20-A-P-A
	25	156975	AEVU-100-25-P-A	157021	AEVU-100-25-A-P-A

Data sheet – Single-acting, basic version

Ordering data – Pushing variants, AEVU					
Piston ø [mm]	Stroke [mm]	Piston rod with female thread		Piston rod with male thread	
		Part no.	Type	Part no.	Type
Variable stroke					
12	1 ... 10	156220	AEVU-12-...-P-A	156260	AEVU-12-...-A-P-A
16	1 ... 25	156221	AEVU-16-...-P-A	156261	AEVU-16-...-A-P-A
20	1 ... 25	156222	AEVU-20-...-P-A	156262	AEVU-20-...-A-P-A
25	1 ... 25	156223	AEVU-25-...-P-A	156263	AEVU-25-...-A-P-A
32	1 ... 25	156224	AEVU-32-...-P-A	156264	AEVU-32-...-A-P-A
40	1 ... 25	156225	AEVU-40-...-P-A	156265	AEVU-40-...-A-P-A
50	1 ... 25	156226	AEVU-50-...-P-A	156266	AEVU-50-...-A-P-A
63	1 ... 25	156227	AEVU-63-...-P-A	156267	AEVU-63-...-A-P-A
80	1 ... 25	156228	AEVU-80-...-P-A	156268	AEVU-80-...-A-P-A
100	1 ... 25	156229	AEVU-100-...-P-A	156269	AEVU-100-...-A-P-A
S2 – Through piston rod					
12	1 ... 10	156230	AEVU-12-...-P-A-S2	156270	AEVU-12-...-A-P-A-S2
16	1 ... 25	156231	AEVU-16-...-P-A-S2	156271	AEVU-16-...-A-P-A-S2
20	1 ... 25	156232	AEVU-20-...-P-A-S2	156272	AEVU-20-...-A-P-A-S2
25	1 ... 25	156233	AEVU-25-...-P-A-S2	156273	AEVU-25-...-A-P-A-S2
32	1 ... 25	156234	AEVU-32-...-P-A-S2	156274	AEVU-32-...-A-P-A-S2
40	1 ... 25	156235	AEVU-40-...-P-A-S2	156275	AEVU-40-...-A-P-A-S2
50	1 ... 25	156236	AEVU-50-...-P-A-S2	156276	AEVU-50-...-A-P-A-S2
63	1 ... 25	156237	AEVU-63-...-P-A-S2	156277	AEVU-63-...-A-P-A-S2
80	1 ... 25	156238	AEVU-80-...-P-A-S2	156278	AEVU-80-...-A-P-A-S2
100	1 ... 25	156239	AEVU-100-...-P-A-S2	156279	AEVU-100-...-A-P-A-S2
S6 – Heat-resistant up to 120°C					
12	1 ... 10	156250	AEVU-12-...-P-A-S6	156310	AEVU-12-...-A-P-A-S6
16	1 ... 25	156251	AEVU-16-...-P-A-S6	156311	AEVU-16-...-A-P-A-S6
20	1 ... 25	156252	AEVU-20-...-P-A-S6	156312	AEVU-20-...-A-P-A-S6
25	1 ... 25	156253	AEVU-25-...-P-A-S6	156313	AEVU-25-...-A-P-A-S6
32	1 ... 25	156254	AEVU-32-...-P-A-S6	156314	AEVU-32-...-A-P-A-S6
40	1 ... 25	156255	AEVU-40-...-P-A-S6	156315	AEVU-40-...-A-P-A-S6
50	1 ... 25	156256	AEVU-50-...-P-A-S6	156316	AEVU-50-...-A-P-A-S6
63	1 ... 25	156257	AEVU-63-...-P-A-S6	156317	AEVU-63-...-A-P-A-S6
80	1 ... 25	156258	AEVU-80-...-P-A-S6	156318	AEVU-80-...-A-P-A-S6
100	1 ... 25	156259	AEVU-100-...-P-A-S6	156319	AEVU-100-...-A-P-A-S6
S26 – Through piston rod, heat resistant up to 120°C					
12	1 ... 10	156240	AEVU-12-...-P-A-S26	156300	AEVU-12-...-A-P-A-S26
16	1 ... 25	156241	AEVU-16-...-P-A-S26	156301	AEVU-16-...-A-P-A-S26
20	1 ... 25	156242	AEVU-20-...-P-A-S26	156302	AEVU-20-...-A-P-A-S26
25	1 ... 25	156243	AEVU-25-...-P-A-S26	156303	AEVU-25-...-A-P-A-S26
32	1 ... 25	156244	AEVU-32-...-P-A-S26	156304	AEVU-32-...-A-P-A-S26
40	1 ... 25	156245	AEVU-40-...-P-A-S26	156305	AEVU-40-...-A-P-A-S26
50	1 ... 25	156246	AEVU-50-...-P-A-S26	156306	AEVU-50-...-A-P-A-S26
63	1 ... 25	156247	AEVU-63-...-P-A-S26	156307	AEVU-63-...-A-P-A-S26
80	1 ... 25	156248	AEVU-80-...-P-A-S26	156308	AEVU-80-...-A-P-A-S26
100	1 ... 25	156249	AEVU-100-...-P-A-S26	156309	AEVU-100-...-A-P-A-S26

Data sheet – Single-acting, basic version

Ordering data – Pushing variants, AEVU					
Piston ø [mm]	Stroke [mm]	Piston rod with female thread		Piston rod with male thread	
		Part no.	Type	Part no.	Type
S20 – Through, hollow piston rod					
12	1 ... 10	–		156280	AEVU-12-...-A-P-A-S20
16	1 ... 25	–		156281	AEVU-16-...-A-P-A-S20
20	1 ... 25	–		156282	AEVU-20-...-A-P-A-S20
25	1 ... 25	–		156283	AEVU-25-...-A-P-A-S20
32	1 ... 25	–		156284	AEVU-32-...-A-P-A-S20
40	1 ... 25	–		156285	AEVU-40-...-A-P-A-S20
50	1 ... 25	–		156286	AEVU-50-...-A-P-A-S20
63	1 ... 25	–		156287	AEVU-63-...-A-P-A-S20
80	1 ... 25	–		156288	AEVU-80-...-A-P-A-S20
100	1 ... 25	–		156289	AEVU-100-...-A-P-A-S20
S206 – Through, hollow piston rod, heat resistant up to 120°C					
12	1 ... 10	–		156290	AEVU-12-...-A-P-A-S206
16	1 ... 25	–		156291	AEVU-16-...-A-P-A-S206
20	1 ... 25	–		156292	AEVU-20-...-A-P-A-S206
25	1 ... 25	–		156293	AEVU-25-...-A-P-A-S206
32	1 ... 25	–		156294	AEVU-32-...-A-P-A-S206
40	1 ... 25	–		156295	AEVU-40-...-A-P-A-S206
50	1 ... 25	–		156296	AEVU-50-...-A-P-A-S206
63	1 ... 25	–		156297	AEVU-63-...-A-P-A-S206
80	1 ... 25	–		156298	AEVU-80-...-A-P-A-S206
100	1 ... 25	–		156299	AEVU-100-...-A-P-A-S206
Ordering data – Pulling variants, basic version, AEVUZ					
Piston ø [mm]	Stroke [mm]	Piston rod with female thread		Piston rod with male thread	
		Part no.	Type	Part no.	Type
12	5	157206	AEVUZ-12-5-P-A	157252	AEVUZ-12-5-A-P-A
	10	157207	AEVUZ-12-10-P-A	157253	AEVUZ-12-10-A-P-A
16	5	157211	AEVUZ-16-5-P-A	157257	AEVUZ-16-5-A-P-A
	10	157212	AEVUZ-16-10-P-A	157258	AEVUZ-16-10-A-P-A
	15	157213	AEVUZ-16-15-P-A	157259	AEVUZ-16-15-A-P-A
	20	157214	AEVUZ-16-20-P-A	157260	AEVUZ-16-20-A-P-A
	25	157215	AEVUZ-16-25-P-A	157261	AEVUZ-16-25-A-P-A
20	5	157216	AEVUZ-20-5-P-A	157262	AEVUZ-20-5-A-P-A
	10	157217	AEVUZ-20-10-P-A	157263	AEVUZ-20-10-A-P-A
	15	157218	AEVUZ-20-15-P-A	157264	AEVUZ-20-15-A-P-A
	20	157219	AEVUZ-20-20-P-A	157265	AEVUZ-20-20-A-P-A
	25	157220	AEVUZ-20-25-P-A	157266	AEVUZ-20-25-A-P-A
25	5	157221	AEVUZ-25-5-P-A	157267	AEVUZ-25-5-A-P-A
	10	157222	AEVUZ-25-10-P-A	157268	AEVUZ-25-10-A-P-A
	15	157223	AEVUZ-25-15-P-A	157269	AEVUZ-25-15-A-P-A
	20	157224	AEVUZ-25-20-P-A	157270	AEVUZ-25-20-A-P-A
	25	157225	AEVUZ-25-25-P-A	157271	AEVUZ-25-25-A-P-A
32	5	157226	AEVUZ-32-5-P-A	157272	AEVUZ-32-5-A-P-A
	10	157227	AEVUZ-32-10-P-A	157273	AEVUZ-32-10-A-P-A
	15	157228	AEVUZ-32-15-P-A	157274	AEVUZ-32-15-A-P-A
	20	157229	AEVUZ-32-20-P-A	157275	AEVUZ-32-20-A-P-A
	25	157230	AEVUZ-32-25-P-A	157276	AEVUZ-32-25-A-P-A

Data sheet – Single-acting, basic version

Ordering data – Pulling variants, basic version, AEVUZ					
Piston ø [mm]	Stroke [mm]	Piston rod with female thread		Piston rod with male thread	
		Part no.	Type	Part no.	Type
40	5	157231	AEVUZ-40-5-P-A	157277	AEVUZ-40-5-A-P-A
	10	157232	AEVUZ-40-10-P-A	157278	AEVUZ-40-10-A-P-A
	15	157233	AEVUZ-40-15-P-A	157279	AEVUZ-40-15-A-P-A
	20	157234	AEVUZ-40-20-P-A	157280	AEVUZ-40-20-A-P-A
	25	157235	AEVUZ-40-25-P-A	157281	AEVUZ-40-25-A-P-A
50	10	157236	AEVUZ-50-10-P-A	157282	AEVUZ-50-10-A-P-A
	15	157237	AEVUZ-50-15-P-A	157283	AEVUZ-50-15-A-P-A
	20	157238	AEVUZ-50-20-P-A	157284	AEVUZ-50-20-A-P-A
	25	157239	AEVUZ-50-25-P-A	157285	AEVUZ-50-25-A-P-A
63	10	157240	AEVUZ-63-10-P-A	157286	AEVUZ-63-10-A-P-A
	15	157241	AEVUZ-63-15-P-A	157287	AEVUZ-63-15-A-P-A
	20	157242	AEVUZ-63-20-P-A	157288	AEVUZ-63-20-A-P-A
	25	157243	AEVUZ-63-25-P-A	157289	AEVUZ-63-25-A-P-A
80	10	157244	AEVUZ-80-10-P-A	157290	AEVUZ-80-10-A-P-A
	15	157245	AEVUZ-80-15-P-A	157291	AEVUZ-80-15-A-P-A
	20	157246	AEVUZ-80-20-P-A	157292	AEVUZ-80-20-A-P-A
	25	157247	AEVUZ-80-25-P-A	157293	AEVUZ-80-25-A-P-A
100	10	157248	AEVUZ-100-10-P-A	157294	AEVUZ-100-10-A-P-A
	15	157249	AEVUZ-100-15-P-A	157295	AEVUZ-100-15-A-P-A
	20	157250	AEVUZ-100-20-P-A	157296	AEVUZ-100-20-A-P-A
	25	157251	AEVUZ-100-25-P-A	157297	AEVUZ-100-25-A-P-A

Ordering data – Pulling variants, AEVUZ					
Piston ø [mm]	Stroke [mm]	Piston rod with female thread		Piston rod with male thread	
		Part no.	Type	Part no.	Type
Variable stroke					
12	1 ... 10	156460	AEVUZ-12-...-P-A	156480	AEVUZ-12-...-A-P-A
16	1 ... 25	156461	AEVUZ-16-...-P-A	156481	AEVUZ-16-...-A-P-A
20	1 ... 25	156462	AEVUZ-20-...-P-A	156482	AEVUZ-20-...-A-P-A
25	1 ... 25	156463	AEVUZ-25-...-P-A	156483	AEVUZ-25-...-A-P-A
32	1 ... 25	156464	AEVUZ-32-...-P-A	156484	AEVUZ-32-...-A-P-A
40	1 ... 25	156465	AEVUZ-40-...-P-A	156485	AEVUZ-40-...-A-P-A
50	1 ... 25	156466	AEVUZ-50-...-P-A	156486	AEVUZ-50-...-A-P-A
63	1 ... 25	156467	AEVUZ-63-...-P-A	156487	AEVUZ-63-...-A-P-A
80	1 ... 25	156468	AEVUZ-80-...-P-A	156488	AEVUZ-80-...-A-P-A
100	1 ... 25	156469	AEVUZ-100-...-P-A	156489	AEVUZ-100-...-A-P-A
S6 – Heat-resistant up to 120°C					
12	1 ... 10	156470	AEVUZ-12-...-P-A-S6	156490	AEVUZ-12-...-A-P-A-S6
16	1 ... 25	156471	AEVUZ-16-...-P-A-S6	156491	AEVUZ-16-...-A-P-A-S6
20	1 ... 25	156472	AEVUZ-20-...-P-A-S6	156492	AEVUZ-20-...-A-P-A-S6
25	1 ... 25	156473	AEVUZ-25-...-P-A-S6	156493	AEVUZ-25-...-A-P-A-S6
32	1 ... 25	156474	AEVUZ-32-...-P-A-S6	156494	AEVUZ-32-...-A-P-A-S6
40	1 ... 25	156475	AEVUZ-40-...-P-A-S6	156495	AEVUZ-40-...-A-P-A-S6
50	1 ... 25	156476	AEVUZ-50-...-P-A-S6	156496	AEVUZ-50-...-A-P-A-S6
63	1 ... 25	156477	AEVUZ-63-...-P-A-S6	156497	AEVUZ-63-...-A-P-A-S6
80	1 ... 25	156478	AEVUZ-80-...-P-A-S6	156498	AEVUZ-80-...-A-P-A-S6
100	1 ... 25	156479	AEVUZ-100-...-P-A-S6	156499	AEVUZ-100-...-A-P-A-S6

Data sheet – Single-acting, basic version

Ordering data – Sets of wearing parts				
	Part no.	Type	Part no.	Type
Piston ø	Basic version		S6 – Heat-resistant up to 120°C	
32	121119	AEVU-32-...-(A)-P-A ¹⁾	383563	AEVU-32-...-(A)-P-A-S6 ¹⁾
40	121120	AEVU-40-...-(A)-P-A ¹⁾	383564	AEVU-40-...-(A)-P-A-S6 ¹⁾
50	121121	AEVU-50-...-(A)-P-A ¹⁾	383565	AEVU-50-...-(A)-P-A-S6 ¹⁾
63	121122	AEVU-63-...-(A)-P-A ¹⁾	383566	AEVU-63-...-(A)-P-A-S6 ¹⁾
80	121123	AEVU-80-...-(A)-P-A ¹⁾	383567	AEVU-80-...-(A)-P-A-S6 ¹⁾
100	121124	AEVU-100-...-(A)-P-A ¹⁾	383568	AEVU-100-...-(A)-P-A-S6 ¹⁾

1) Mounting grease included in the scope of delivery

2) Mounting grease not included in scope of delivery. If required, please order separately using part no. 329 555 (20 ml)

Data sheet – Single-acting, protected against rotation with square piston rod

Function

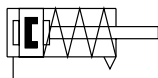

Variants

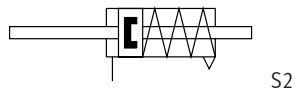

⌀ - Diameter
16 ... 100 mm

— - Stroke length
1 ... 25 mm

www.festo.com



AEVULQ-...-...-P-A



AEVULQ-...-...-P-A-S2

General technical data		16	20	25	32	40	50	63	80	100
Piston ⌀		16	20	25	32	40	50	63	80	100
Pneumatic connection		M5	M5	M5	G1/8	G1/8	G1/8	G1/8	G1/8	G1/4
Piston rod end	Female thread	M4	M5	M5	M6	M6	M8	M8	M10	M12
	Male thread	M8	M10x1.25				M12x1.25		M16x1.5	M20x1.5
Operating medium	Compressed air to ISO 8573-1:2010 [7:4:4]									
Note on the operating/ pilot medium	Lubricated operation possible (in which case lubricated operation will always be required)									
Design	Piston									
	Piston rod									
Cushioning	Elastic cushioning rings/pads at both ends									
Position sensing	Via proximity switch									
Type of mounting	Via through-hole									
	With female thread									
	With accessories									
Mounting position	Any									

Note
This product conforms to ISO 1179-1
and ISO 228-1

Operating pressure [bar]		16	20	25	32	40	50	63	80	100
Piston ⌀		16	20	25	32	40	50	63	80	100
Piston rod at one end		1.3 ... 10		1.0 ... 10		0.8 ... 10		0.6 ... 10		
Through piston rod S2		1.5 ... 10		1.4 ... 10		1.2 ... 10		1.0 ... 10		

Environmental conditions		Basic version
Compact cylinder		Basic version
Ambient temperature ¹⁾	[°C]	-20 ... +80
Corrosion resistance class CRC ²⁾		2

1) Note operating range of proximity switches
2) Corrosion resistance class CRC 2 to Festo standard FN 940070
Moderate corrosion stress. Indoor applications in which condensation can occur. External visible parts with primarily decorative surface requirements which are in direct contact with a normal industrial environment.

Data sheet – Single-acting, protected against rotation with square piston rod

Forces [N]									
Piston \varnothing	16	20	25	32	40	50	63	80	100
Theoretical force at 6 bar, advancing	111	171	269	450	704	1121	1799	2902	4516
S2	81	123	221	382	636	999	1679	2733	4222

Data sheet – Square piston rod									
Piston \varnothing	16	20	25	32	40	50	63	80	100
Max. torque at the piston rod ¹⁾ [Nm]	0.20	0.45	0.45	0.80	0.80	1.10	1.10	1.50	3.00
Max. torsional backlash of piston rod [°]	±0.9	±0.8	±0.8	±0.6	±0.6	±0.5	±0.5	±0.4	±0.4
Piston rod distortion [°/50 mm]	0.30	0.25	0.25	0.20	0.20	0.15	0.15	0.15	0.09

1) The max. torque must not be exceeded even when attaching mounting components to the piston rod

Spring return force F as a function of stroke l

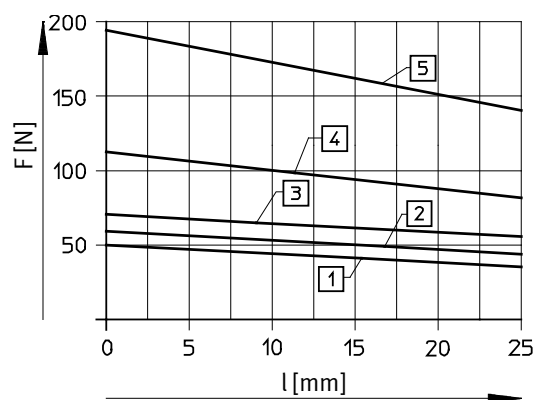
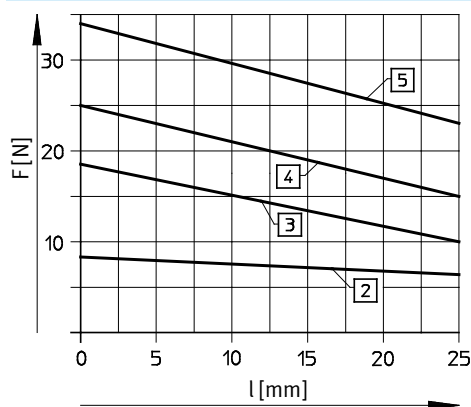

- [2] \varnothing 16
 [3] \varnothing 20
 [4] \varnothing 25
 [5] \varnothing 32

- [1] \varnothing 40
 [2] \varnothing 50
 [3] \varnothing 63
 [4] \varnothing 80
 [5] \varnothing 100

Weight [g]									
Piston \varnothing	16	20	25	32	40	50	63	80	100
Product weight with 0 mm stroke	89	149	180	300	433	560	1059	1772	2797
Additional weight per 10 mm stroke	15	23	28	40	59	72	107	168	177
Moving mass with 0 mm stroke	12	20	26	49	63	112	134	307	614
Additional mass per 10 mm stroke	4	6	6	9	9	16	16	25	38

Data sheet – Single-acting, protected against rotation with square piston rod

Materials

Sectional view

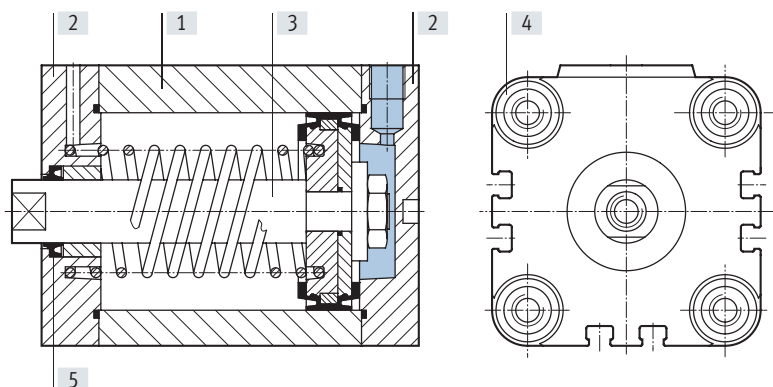

Compact cylinder		Basic version
[1] Cylinder barrel		Wrought aluminium alloy
[2] Cover		Wrought aluminium alloy
[3] Piston rod	∅ 16 ... 32 ∅ 40 ... 100	High-alloy stainless steel High-alloy steel
[4] Flange screws	∅ 16 ∅ 20 ... 100	High-alloy stainless steel Galvanised steel
[5] Dynamic seals		Polyurethane

Dimensions – Basic cylinders

Download CAD data → www.festo.com

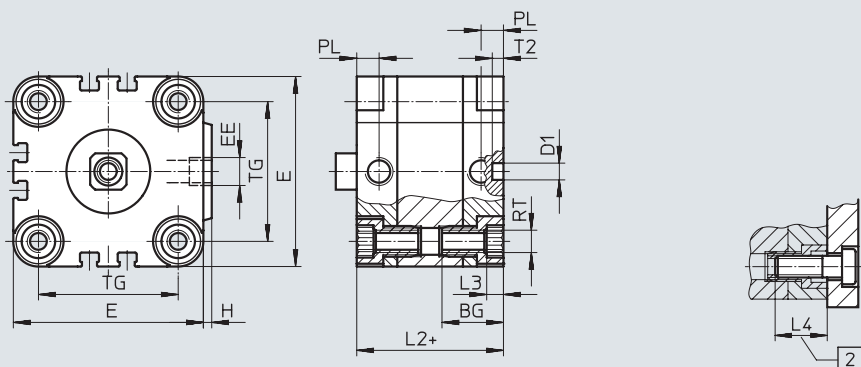

Note
 To mount from above with piston diameter 16 mm, only use 2 diagonal screws or use non-magnetic screws.
 + = plus stroke length
 [2] Minimum screw-in depth

∅	BG	D1 ∅ H9	E	EE	H	L2	L3	L4	PL	RT	T2	TG
[mm]											-0.2	
16	18.5	6	29	M5	1	38	3	16	8	M4	4	18
20	18.5	6	36	M5	1.5	38	4	18	8	M5	4	22
25	18.5	6	40	M5	1.5	39.5	4	18	8	M5	4	26
32	21.5	6	50	G1/8	2	44.5	5	20	8	M6	4	32
40	21.5	6	60	G1/8	2.5	45.5	5	20	8	M6	4	42
50	22	6	68	G1/8	3	45.5	6	20	8	M8	4	50
63	24.5	8	87	G1/8	4	50	8	25	8	M10	4	62
80	27.5	8	107	G1/8	4	56	8	25	8.5	M10	4	82
100	32.5	8	128	G1/4	5	66.5	8	25	10.5	M10	4	103

Note
 This product conforms to ISO 1179-1 and ISO 228-1

Data sheet – Single-acting, protected against rotation with square piston rod

Dimensions

Download CAD data → www.festo.com

Basic version

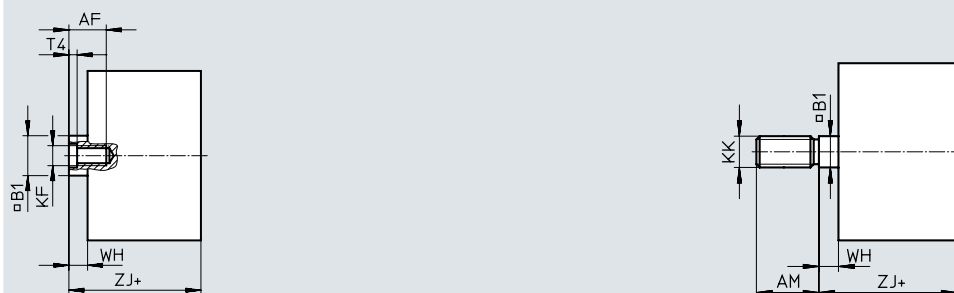

S2 – Through piston rod

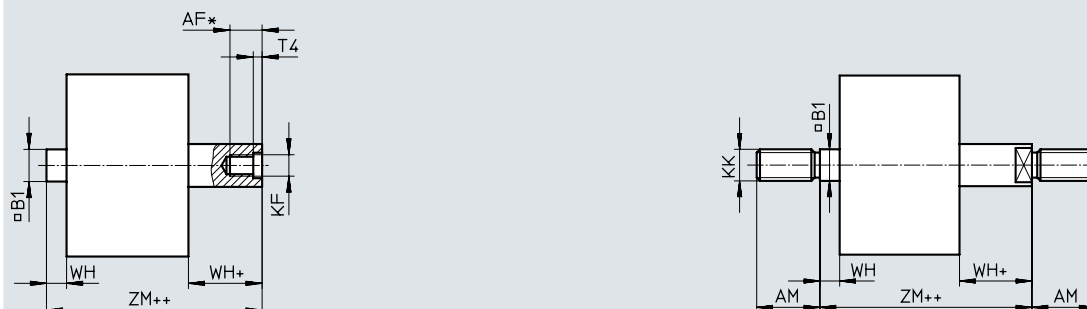

+ = plus stroke length

++ = plus 2x stroke length

∅ [mm]	AF	AM	B1 □	D8	D9 ∅	KF	KK	T4	WH	ZJ	ZM
16	10	20	7	–	3.2	M4	M8	1.5	4.5	42.5	47
20 ²⁾	12	22	9	–	3.8	M5	M10x1.25	2	4.5	42.5	47
25 ²⁾	12	22	9	–	3.8	M5	M10x1.25	2	5.5	45	50.5
32 ²⁾	14	22	10	–	4.5	M6	M10x1.25	2.6	6	50.5	56.5
40 ²⁾	14	22	10	–	4.5	M6	M10x1.25	2.6	6.5	52	58.5
50 ²⁾	16	24	12	–	6	M8	M12x1.25	3.3	7.5	53	60.5
63 ²⁾	16	24	12	–	6	M8	M12x1.25	3.3	7.5	57.5	65
80 ²⁾	20 ¹⁾	32	16	G1/8	8	M10	M16x1.5	4.7	8	64	72
100 ²⁾	24 ¹⁾	40	20	G1/4	11.7	M12	M20x1.5	6.1	10	76.5	86.5

1) With a stroke < 5 mm, the maximum screw-in depth is reduced by 5 mm

2) Nut for piston rod thread included in the scope of delivery

Data sheet – Single-acting, protected against rotation with square piston rod

Ordering data – Basic version AEVULQ					
Piston ø [mm]	Stroke [mm]	Piston rod with female thread		Piston rod with male thread	
		Part no.	Type	Part no.	Type
16	5	157027	AEVULQ-16-5-P-A	157073	AEVULQ-16-5-A-P-A
	10	157028	AEVULQ-16-10-P-A	157074	AEVULQ-16-10-A-P-A
	15	157029	AEVULQ-16-15-P-A	157075	AEVULQ-16-15-A-P-A
	20	157030	AEVULQ-16-20-P-A	157076	AEVULQ-16-20-A-P-A
	25	157031	AEVULQ-16-25-P-A	157077	AEVULQ-16-25-A-P-A
20	5	157032	AEVULQ-20-5-P-A	157078	AEVULQ-20-5-A-P-A
	10	157033	AEVULQ-20-10-P-A	157079	AEVULQ-20-10-A-P-A
	15	157034	AEVULQ-20-15-P-A	157080	AEVULQ-20-15-A-P-A
	20	157035	AEVULQ-20-20-P-A	157081	AEVULQ-20-20-A-P-A
	25	157036	AEVULQ-20-25-P-A	157082	AEVULQ-20-25-A-P-A
25	5	157037	AEVULQ-25-5-P-A	157083	AEVULQ-25-5-A-P-A
	10	157038	AEVULQ-25-10-P-A	157084	AEVULQ-25-10-A-P-A
	15	157039	AEVULQ-25-15-P-A	157085	AEVULQ-25-15-A-P-A
	20	157040	AEVULQ-25-20-P-A	157086	AEVULQ-25-20-A-P-A
	25	157041	AEVULQ-25-25-P-A	157087	AEVULQ-25-25-A-P-A
32	5	157042	AEVULQ-32-5-P-A	157088	AEVULQ-32-5-A-P-A
	10	157043	AEVULQ-32-10-P-A	157089	AEVULQ-32-10-A-P-A
	15	157044	AEVULQ-32-15-P-A	157090	AEVULQ-32-15-A-P-A
	20	157045	AEVULQ-32-20-P-A	157091	AEVULQ-32-20-A-P-A
	25	157046	AEVULQ-32-25-P-A	157092	AEVULQ-32-25-A-P-A
40	5	157047	AEVULQ-40-5-P-A	157093	AEVULQ-40-5-A-P-A
	10	157048	AEVULQ-40-10-P-A	157094	AEVULQ-40-10-A-P-A
	15	157049	AEVULQ-40-15-P-A	157095	AEVULQ-40-15-A-P-A
	20	157050	AEVULQ-40-20-P-A	157096	AEVULQ-40-20-A-P-A
	25	157051	AEVULQ-40-25-P-A	157097	AEVULQ-40-25-A-P-A
50	10	157052	AEVULQ-50-10-P-A	157098	AEVULQ-50-10-A-P-A
	15	157053	AEVULQ-50-15-P-A	157099	AEVULQ-50-15-A-P-A
	20	157054	AEVULQ-50-20-P-A	157100	AEVULQ-50-20-A-P-A
	25	157055	AEVULQ-50-25-P-A	157101	AEVULQ-50-25-A-P-A
63	10	157056	AEVULQ-63-10-P-A	157102	AEVULQ-63-10-A-P-A
	15	157057	AEVULQ-63-15-P-A	157103	AEVULQ-63-15-A-P-A
	20	157058	AEVULQ-63-20-P-A	157104	AEVULQ-63-20-A-P-A
	25	157059	AEVULQ-63-25-P-A	157105	AEVULQ-63-25-A-P-A
80	10	157060	AEVULQ-80-10-P-A	157106	AEVULQ-80-10-A-P-A
	15	157061	AEVULQ-80-15-P-A	157107	AEVULQ-80-15-A-P-A
	20	157062	AEVULQ-80-20-P-A	157108	AEVULQ-80-20-A-P-A
	25	157063	AEVULQ-80-25-P-A	157109	AEVULQ-80-25-A-P-A
100	10	157064	AEVULQ-100-10-P-A	157110	AEVULQ-100-10-A-P-A
	15	157065	AEVULQ-100-15-P-A	157111	AEVULQ-100-15-A-P-A
	20	157066	AEVULQ-100-20-P-A	157112	AEVULQ-100-20-A-P-A
	25	157067	AEVULQ-100-25-P-A	157113	AEVULQ-100-25-A-P-A

Data sheet – Single-acting, protected against rotation with square piston rod

Ordering data – Variants AEVULQ					
Piston Ø [mm]	Stroke [mm]	Piston rod with female thread		Piston rod with male thread	
		Part no.	Type	Part no.	Type
Variable stroke					
16	1 ... 25	156321	AEVULQ-16-...-P-A	156361	AEVULQ-16-...-A-P-A
20	1 ... 25	156322	AEVULQ-20-...-P-A	156362	AEVULQ-20-...-A-P-A
25	1 ... 25	156323	AEVULQ-25-...-P-A	156363	AEVULQ-25-...-A-P-A
32	1 ... 25	156324	AEVULQ-32-...-P-A	156364	AEVULQ-32-...-A-P-A
40	1 ... 25	156325	AEVULQ-40-...-P-A	156365	AEVULQ-40-...-A-P-A
50	1 ... 25	156326	AEVULQ-50-...-P-A	156366	AEVULQ-50-...-A-P-A
63	1 ... 25	156327	AEVULQ-63-...-P-A	156367	AEVULQ-63-...-A-P-A
80	1 ... 25	156328	AEVULQ-80-...-P-A	156368	AEVULQ-80-...-A-P-A
100	1 ... 25	156329	AEVULQ-100-...-P-A	156369	AEVULQ-100-...-A-P-A
S2 – Through piston rod					
16	1 ... 25	156331	AEVULQ-16-...-P-A-S2	156371	AEVULQ-16-...-A-P-A-S2
20	1 ... 25	156332	AEVULQ-20-...-P-A-S2	156372	AEVULQ-20-...-A-P-A-S2
25	1 ... 25	156333	AEVULQ-25-...-P-A-S2	156373	AEVULQ-25-...-A-P-A-S2
32	1 ... 25	156334	AEVULQ-32-...-P-A-S2	156374	AEVULQ-32-...-A-P-A-S2
40	1 ... 25	156335	AEVULQ-40-...-P-A-S2	156375	AEVULQ-40-...-A-P-A-S2
50	1 ... 25	156336	AEVULQ-50-...-P-A-S2	156376	AEVULQ-50-...-A-P-A-S2
63	1 ... 25	156337	AEVULQ-63-...-P-A-S2	156377	AEVULQ-63-...-A-P-A-S2
80	1 ... 25	156338	AEVULQ-80-...-P-A-S2	156378	AEVULQ-80-...-A-P-A-S2
100	1 ... 25	156339	AEVULQ-100-...-P-A-S2	156379	AEVULQ-100-...-A-P-A-S2

Data sheet – Single-acting, protected against rotation with square piston rod

Ordering data – Variants AEVULQ					
Piston ø [mm]	Stroke [mm]	Piston rod with female thread		Piston rod with male thread	
		Part no.	Type	Part no.	Type
S206 – Through, hollow piston rod, heat resistant up to 120°C					
16	1 ... 25	–		156391	AEVULQ-16-...-A-P-A-S206
20	1 ... 25			156392	AEVULQ-20-...-A-P-A-S206
25	1 ... 25			156393	AEVULQ-25-...-A-P-A-S206
32	1 ... 25			156394	AEVULQ-32-...-A-P-A-S206
40	1 ... 25			156395	AEVULQ-40-...-A-P-A-S206
50	1 ... 25			156396	AEVULQ-50-...-A-P-A-S206
63	1 ... 25			156397	AEVULQ-63-...-A-P-A-S206
80	1 ... 25			156398	AEVULQ-80-...-A-P-A-S206
100	1 ... 25			156399	AEVULQ-100-...-A-P-A-S206

Accessories

Foot mounting HUA

For piston \varnothing 12 ... 100 mm

Foot mounting HNC

For piston \varnothing 125 mm

(not illustrated)

Material:

HUA/HNC: Galvanised steel

HUA-...-R3: Steel, silver protective coating

CRHNC: High-alloy stainless steel

Free of copper and PTFE

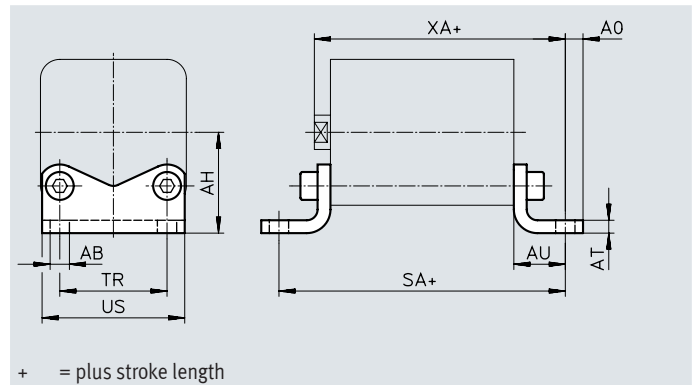

Dimensions and ordering data

For \varnothing	AB \varnothing	AH	AO	AT	AU	SA		TR	US	XA	
						ADVU-...	ADVU-...-S1			ADVU-...	ADVU-...-S1
12/16	5.5	22	4.75	3	13	64	-	18	27	55.5	-
20	6.6	27	6.25	4	16	70	-	22	34	58.5	-
25	6.6	29	6.25	4	16	71.5	77.5	26	38	61	73
32	6.6	34	8.25	5	18	80.5	-	32	48	68.5	-
40	9	40.5	8.25	5	20	85.5	92.5	42	58	72	89
50	9	47	8.25	6	24	93.5	-	50	66	77	-
63	11	56.5	11.75	6	27	104	112	62	85	84.5	106.5
80	11	68.5	11.75	8	30	116	-	82	105	94	-
100	13.5	81	11.75	8	33	132.5	143.5	103	126	109.5	137.5
125	16.5	90	22	8	45	171	-	90	131	144	-

For \varnothing	Weight [g]	Basic version			Weight [g]	R3 – High corrosion protection		
		CRC ¹⁾	Part no.	Type		CRC ¹⁾	Part no.	Type
12/16	45	1	157309	HUA-12/16	45	3	176873	HUA-12/16-R3
20	88	1	157310	HUA-20	70	3	176874	HUA-20-R3
25	94	1	157311	HUA-25	76	3	176875	HUA-25-R3
32	171	1	157312	HUA-32	175	3	176876	HUA-32-R3
40	220	1	157313	HUA-40	224	3	176877	HUA-40-R3
50	344	1	157314	HUA-50	352	3	176878	HUA-50-R3
63	581	1	157315	HUA-63	593	3	176879	HUA-63-R3
80	878	1	157316	HUA-80	902	3	176880	HUA-80-R3
100	1117	1	157317	HUA-100	1128	3	176881	HUA-100-R3
		Basic version				Corrosion-resistant		
125	1840	2	174375	HNC-125	1840	4	176943	CRHNC-125

1) Corrosion resistance class CRC 1 to Festo standard FN 940070

Low corrosion stress. Dry indoor application or transport and storage protection. Also applies to parts behind covers, in the non-visible interior area, and parts which are covered in the application (e.g. drive trunnions).

Corrosion resistance class CRC 2 to Festo standard FN 940070

Moderate corrosion stress. Indoor applications in which condensation can occur. External visible parts with primarily decorative surface requirements which are in direct contact with a normal industrial environment.

Corrosion resistance class CRC 3 to Festo standard FN 940070

High corrosion stress. Outdoor exposure under moderate corrosive conditions. External visible parts with primarily functional surface requirements which are in direct contact with a normal industrial environment.

Corrosion resistance class CRC 4 to Festo standard FN 940070

Particularly high corrosion stress. Outdoor exposure under extreme corrosive conditions. Parts exposed to aggressive media, e.g. in the chemical or food industries. Such applications may need to be safeguarded by means of special testing (→ also FN 940082), using appropriate media.

Accessories

Flange mounting FUA

For piston \varnothing 12 ... 100 mm

Flange mounting FNC

For piston \varnothing 125 mm
(not illustrated)

Material:

FUA: Wrought aluminium alloy

FNC: Galvanised steel

Free of copper and PTFE

RoHS-compliant

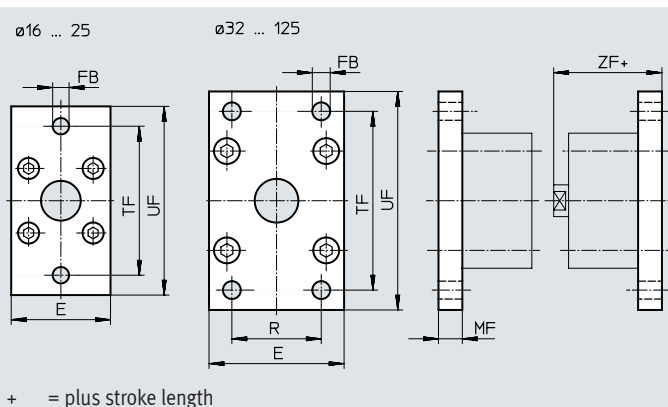

Dimensions and ordering data

For \varnothing	E	FB \varnothing	MF	R	TF	UF
12/16	29	5.5	10	–	43	55
20	36	6.6	10	–	55	70
25	40	6.6	10	–	60	76
32	50	7	10	32	65	80
40	60	9	10	36	82	102
50	68	9	12	45	90	110
63	87	9	15	50	110	130
80	107	12	15	63	135	160
100	128	14	15	75	163	190
125	132	16	20	90	180	210

For \varnothing	ZF		CRC ¹⁾	Weight [g]	Part no.	Type
	ADVU-...	ADVU-...S1				
12/16	52.5	–	2	48	157299	FUA-12/16
20	52.5	–	2	77	157300	FUA-20
25	55	67	2	91	157301	FUA-25
32	60.5	–	2	290	157302	FUA-32
40	62	79	2	449	157303	FUA-40
50	65	–	2	658	157304	FUA-50
63	72.5	91.5	2	1277	157305	FUA-63
80	76	–	2	1910	157306	FUA-80
100	91.5	119.5	2	2716	157307	FUA-100
125	119	–	1	3775	174382	FNC-125

1) Corrosion resistance class CRC 1 to Festo standard FN 940070

Low corrosion stress. Dry indoor application or transport and storage protection. Also applies to parts behind covers, in the non-visible interior area, and parts which are covered in the application (e.g. drive trunnions).

Corrosion resistance class CRC 2 to Festo standard FN 940070

Moderate corrosion stress. Indoor applications in which condensation can occur. External visible parts with primarily decorative surface requirements which are in direct contact with a normal industrial environment.

Accessories

Swivel flange SUA

For piston \varnothing 12 ... 25 mm

Material:

SUA: Anodised aluminium
 SUA- ... -R3: Aluminium, silver protective coating
 Free of copper and PTFE

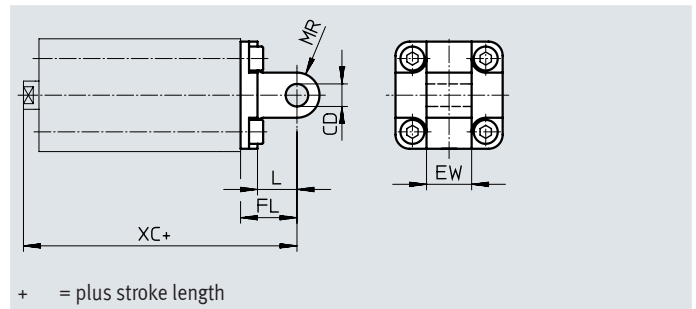

For piston \varnothing 32 ... 100 mm

Material:

SUA: Anodised aluminium
 SUA- ... -R3: Aluminium, silver protective coating
 Free of copper and PTFE

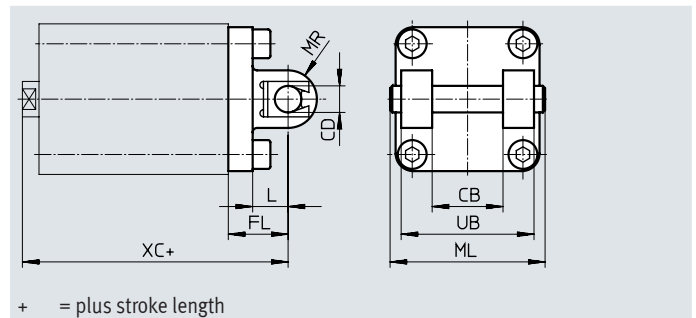

Dimensions and ordering data

For \varnothing	CB	CD \varnothing	EW	FL	L	ML	MR	UB	XC	
									ADVU-...	ADVU-...S1
12/16	-	6	12	16	10	-	6	-	58.5	-
20	-	8	16	20	14	-	8	-	62.5	-
25	-	8	16	20	14	-	8	-	65	77
32	26	10	-	22	13	54	10	45	72.5	-
40	28	12	-	25	16	62	12	52	77	94
50	32	12	-	27	16	70	12	60	80	-
63	40	16	-	32	21	82	16	70	89.5	111.5
80	50	16	-	36	23	102	16	90	100	-
100	60	20	-	41	26	126	20	110	117.5	145.5

For \varnothing	Weight [g]	Basic version		Weight [g]	R3 - High corrosion protection	
		Part no.	Type		Part no.	Type
12/16	22	157319	SUA-12/16	22	176883	SUA-12/16-R3
20	41	157320	SUA-20	41	176884	SUA-20-R3
25	45	157321	SUA-25	45	176885	SUA-25-R3
32	137	157322	SUA-32	135	176886	SUA-32-R3
40	199	157323	SUA-40	194	176887	SUA-40-R3
50	287	157324	SUA-50	283	176888	SUA-50-R3
63	530	157325	SUA-63	527	176889	SUA-63-R3
80	763	157326	SUA-80	770	176890	SUA-80-R3
100	1283	157327	SUA-100	1234	176891	SUA-100-R3

Note
 The maximum stroke length must not be exceeded when combining cylinders and swivel flanges.

For \varnothing	Max. stroke length [mm]
12	50
16	50
20	50
25	50
32	100

For \varnothing	Max. stroke length [mm]
40	100
50	100
63	100
80	150
100	150

Accessories

Swivel flange SNC-125 For piston \varnothing 125 mm

Material:
Die-cast aluminium
Free of copper and PTFE
RoHS-compliant

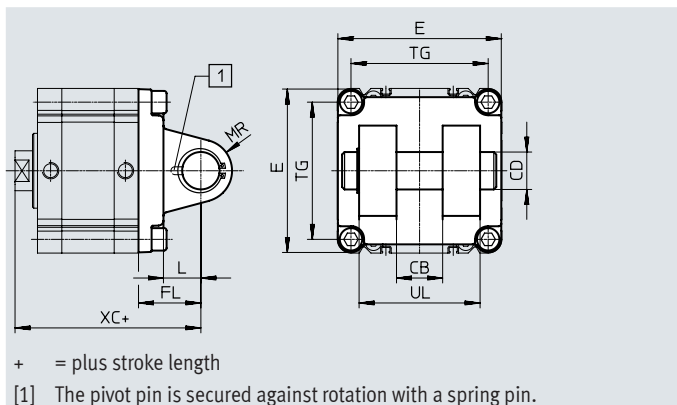

Ordering data

For \varnothing	CB	CD	E	FL	L	MR	TG	UL	XC	CRC ¹⁾	Weight	Basic version	Type
	H14	\varnothing H9	-0.8	± 0.2				h14			[g]	Part no.	
125	37	30	131	50	30	25	110	97	149	1	1740	174389	SNC-125

1) Corrosion resistance class CRC 1 to Festo standard FN 940070

Low corrosion stress. Dry indoor application or transport and storage protection. Also applies to parts behind covers, in the non-visible interior area, and parts which are covered in the application (e.g. drive trunnions).

Swivel flange SNCB-125 For piston \varnothing 125 mm

Material:
SNCB-125: Die-cast aluminium
SNCB-125-R3: Die-cast aluminium
with protective coating
Free of copper and PTFE
RoHS-compliant

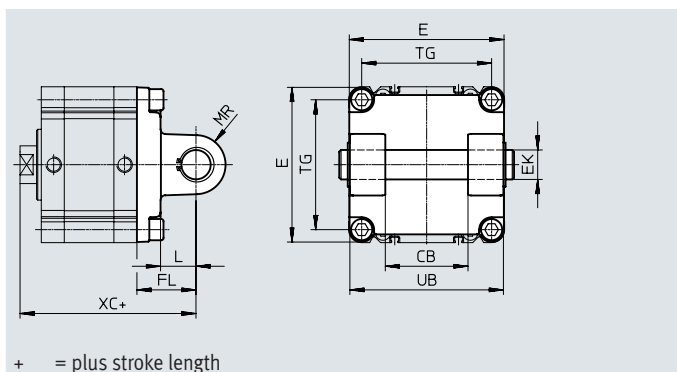

Ordering data

For \varnothing	CB	E	EK	FL	L	MR	TG	UB	XC
[mm]	H14	-0.8	\varnothing H9/e8	± 0.2		-0.5		h14	
125	70	131	25	50	30	25	110	130	149

For \varnothing	Basic version				R3 – High corrosion protection			
	CRC ¹⁾	Weight [g]	Part no.	Type	CRC ¹⁾	Weight [g]	Part no.	Type
125	1	1860	174396	SNCB-125	3	1776	176950	SNCB-125-R3

1) Corrosion resistance class CRC 1 to Festo standard FN 940070

Low corrosion stress. Dry indoor application or transport and storage protection. Also applies to parts behind covers, in the non-visible interior area, and parts which are covered in the application (e.g. drive trunnions).

Corrosion resistance class CRC 3 to Festo standard FN 940070

High corrosion stress. Outdoor exposure under moderate corrosive conditions. External visible parts with primarily functional surface requirements which are in direct contact with a normal industrial environment.

Accessories

Swivel flange SNCS-125 For piston \varnothing 125 mm

Material:
SNCS-125: Wrought aluminium alloy
SNCS-125-R3: Wrought aluminium alloy with protective coating
RoHS-compliant

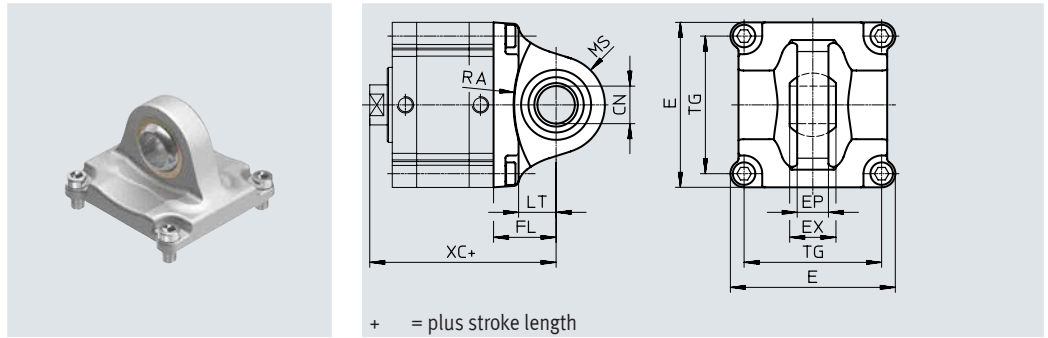

Dimensions and ordering data

For \varnothing	CN		E		EP	EX	FL
	\varnothing		ADVU-...	ADVU-...-R3			
125	$30^{+0.018}$	$30+0.021/-0.04$	$132+1/-0.7$	$132+1/-0.7$	± 0.2	37	± 0.2

For \varnothing	LT	MS		RA		TG	XC
		ADVU-...	ADVU-...-R3	ADVU-... +1	ADVU-...-R3 +1		
125	30	39 ± 0.5	39 ± 0.5	100	100	110	149

Basic version					R3 – High corrosion protection			
For \varnothing	CRC ¹⁾	Weight [g]	Part no.	Type	CRC ¹⁾	Weight [g]	Part no.	Type
125	2	1369	174403	SNCS-125	3	1369	2895926	SNCS-125-R3

- 1) Corrosion resistance class CRC 2 to Festo standard FN 940070
Moderate corrosion stress. Indoor applications in which condensation can occur. External visible parts with primarily decorative surface requirements which are in direct contact with a normal industrial environment.
Corrosion resistance class CRC 3 to Festo standard FN 940070
High corrosion stress. Outdoor exposure under moderate corrosive conditions. External visible parts with primarily functional surface requirements which are in direct contact with a normal industrial environment.

Swivel flange SNCL-125 For piston \varnothing 125 mm

Material:
Die-cast aluminium
Free of copper and PTFE
RoHS-compliant

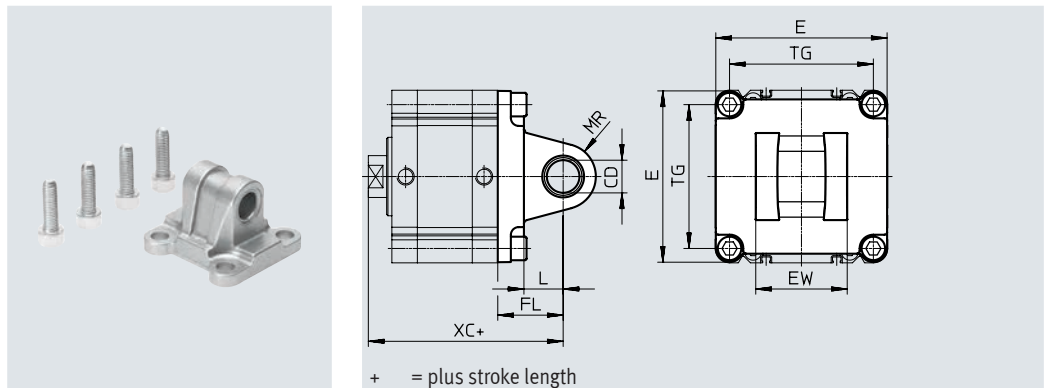

Ordering data												
For \varnothing	CD \varnothing H9	E	EW	FL	L	MR	TG	XC	CRC ¹⁾	Weight [g]	Basic version	
											Part no.	Type
125	25	131	70	50	30	25	110	149	1	1135	174410	SNCL-125

- 1) Corrosion resistance class CRC 1 to Festo standard FN 940070
Low corrosion stress. Dry indoor application or transport and storage protection. Also applies to parts behind covers, in the non-visible interior area, and parts which are covered in the application (e.g. drive trunnions).

Accessories

Trunnion flange ZNCF-125 For piston \varnothing 125 mm

Material:
High-alloy stainless steel
Free of copper and PTFE
RoHS-compliant

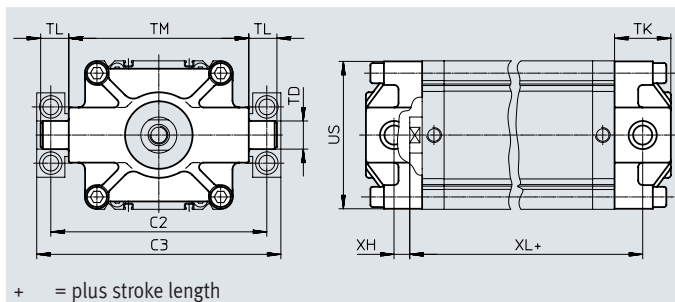
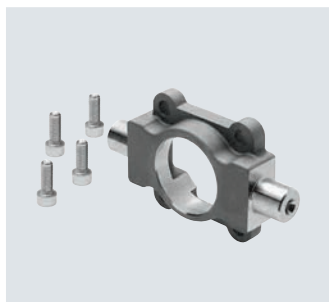

Ordering data

For \varnothing	C2	C3	TD \varnothing e9	TK max.	TL +0.5/-0.7	TM h14	US	XH	XL	Weight [g]	Basic version	
											Part no.	Type
125	192	217	25	50	24.5	160	131	14	124	3484	174417	ZNCF-125

Trunnion mounting kit DAMT-V7-125-A For piston \varnothing 125 mm

Material:
Galvanised steel
Free of copper and PTFE
RoHS-compliant

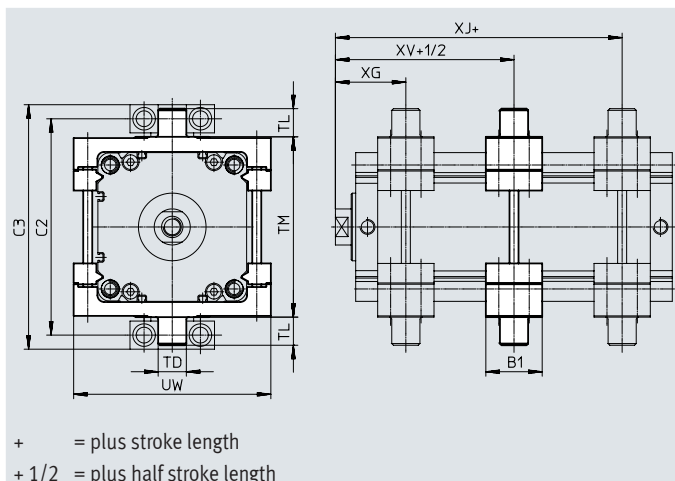
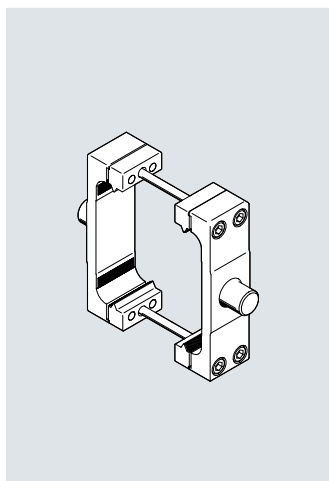

Note

The trunnion mounting kit can be attached to the cylinder profile barrel at any position.

Ordering data

For \varnothing	C1	C2	B1	TD \varnothing e9	TL	TM	UW	XG	XV	XJ	CRC ¹⁾	Weight [g]	Basic version	
													Part no.	Type
125	217	192	50	25	25	160	175	62.5	58.5	54.5	1	3013	163531	DAMT-V7-125-A

1) Corrosion resistance class CRC 1 to Festo standard FN 940070

Low corrosion stress. Dry indoor application or transport and storage protection. Also applies to parts behind covers, in the non-visible interior area, and parts which are covered in the application (e.g. drive trunnions).

Accessories

Multi-position kit DPVU For piston \varnothing 12 ... 100 mm

Material:
Wrought aluminium alloy
Free of copper and PTFE
RoHS-compliant

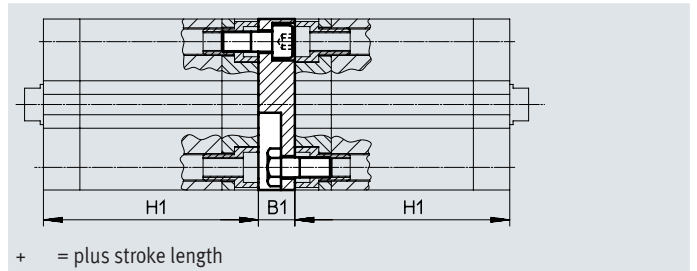

Multi-position kit DPNC For piston \varnothing 125 mm

Material:
Flange: Wrought aluminium alloy
Threaded pins, hex nuts: Galvanised steel

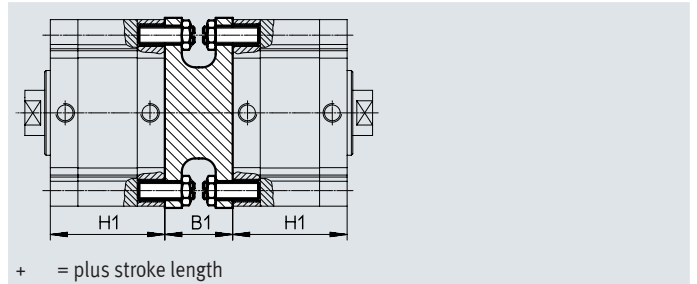
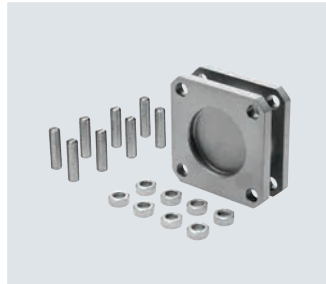

Dimensions and ordering data								
For \varnothing	B1	H	Max. overall stroke length [mm]	CRC ¹⁾	Weight [g]	Part no.	Type	
12/16	12.5	38	400	2	35	161194	DPVU-12/16	
20	12.5	38	600		54	161195	DPVU-20	
25	13	39.5		800	65	161196	DPVU-25	
32	14.5	44.5	111		161197	DPVU-32		
40	14.5	45.5	155		161198	DPVU-40		
50	14.5	45.5	212		161199	DPVU-50		
63	14.5	50	1000	372	161200	DPVU-63		
80	16.5	56		580	161201	DPVU-80		
100	19.5	66.5		935	161202	DPVU-100		
125	48	81		2102	174424	DPNC-125		



Note

The maximum total stroke length must not be exceeded when combining cylinders and multi-position kits.

1) Corrosion resistance class CRC 2 to Festo standard FN 940070

Moderate corrosion stress. Indoor applications in which condensation can occur. External visible parts with primarily decorative surface requirements which are in direct contact with a normal industrial environment.

Connecting two cylinders with identical piston diameters to form a 3- or 4-position cylinder

A 3- or 4-position cylinder consists of two separate cylinders whose piston rods advance in opposing directions. This means that, depending on actuation and stroke division, this type of cylinder can assume up to four positions. In each case the cylinder is driven precisely against a stop.

Note that when one end of the piston rod is fixed, the cylinder barrel executes the movement. The connections to the cylinder must therefore be flexible.

To achieve 3 positions

Two cylinders with the same stroke length must be connected together.

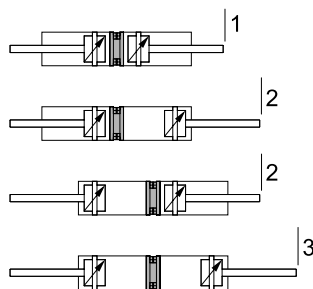

To achieve 4 positions



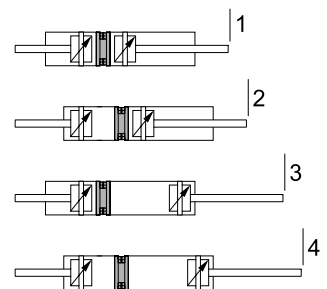

Two cylinders with different stroke lengths must be connected together.





Accessories

Ordering data – Mounting components

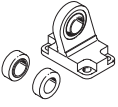
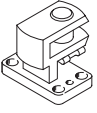

Data sheets → Internet: clevis foot

Designation	For ø	Part no.	Type
Clevis foot LBN			
	12	6058	LBN-12/16
	16	6058	LBN-12/16
	20	6059	LBN-20/25
	25	6059	LBN-20/25
Clevis foot LN			
	32	5147	LN-32
	40	5148	LN-40
	50	5149	LN-50
	63	5150	LN-63
	80	5151	LN-80
	100	5152	LN-100
	125	9036	LN-125
Clevis foot LBG			
	20, 25, 32, 40	31761	LBG-32
	50, 63	31762	LBG-40
	80	31763	LBG-50
		31764	LBG-63
	100	31765	LBG-80
		31766	LBG-100
	125	31767	LBG-125
Swivel flange SNCL			
	32	174404	SNCL-32
	40	174405	SNCL-40
	50	174406	SNCL-50
	63	174407	SNCL-63
	80	174408	SNCL-80
	100	174409	SNCL-100
	125	174410	SNCL-125

Designation	For ø	Part no.	Type
Clevis foot LNG			
	32	33890	LNG-32
	40	33891	LNG-40
	50	33892	LNG-50
	63	33893	LNG-63
	80	33894	LNG-80
	100	33895	LNG-100
Clevis foot LSN			
	32	5561	LSN-32
	40	5562	LSN-40
	50	5563	LSN-50
	63	5564	LSN-63
	80	5565	LSN-80
	100	5566	LSN-100
	125	6987	LSN-125
Right-angle clevis foot LQG			
	20, 25, 32, 40	31768	LQG-32
	50, 63	31769	LQG-40
	80	31770	LQG-50
		31771	LQG-63
	100	31772	LQG-80
		31773	LQG-100
	125	31774	LQG-125
Clevis foot LSNSG			
	125	31753	LSNSG-125
Trunnion support LNZG			
	125	32962	LNZG-100/125

Accessories

Ordering data – Mounting components, corrosion and acid resistant

Designation	For \varnothing	Part no.	Type
Clevis foot CRLBN			
	12	161862	CRLBN-12/16
	16	161862	CRLBN-12/16
	20	161863	CRLBN-20/25
	25	161863	CRLBN-20/25
Trunnion support CRLNZG			
	125	161877	CRLNZG-100/125

Data sheets → Internet: clevis foot

Designation	For \varnothing	Part no.	Type
Clevis foot CRLNG			
	32	161840	CRLNG-32
	40	161841	CRLNG-40
	50	161842	CRLNG-50
	63	161843	CRLNG-63
	80	161844	CRLNG-80
	100	161845	CRLNG-100





Ordering data – Mounting components, R3 – high corrosion protection

Designation	For \varnothing	Part no.	Type
Clevis foot LBG-R3			
	20, 25, 32, 40	2078790	LBG-32-R3
	50, 63	2078792	LBG-40-R3
	80	2078794	LBG-50-R3
		2078795	LBG-63-R3
	100	2078797	LBG-80-R3
		2078799	LBG-100-R3
125	2078837	LBG-125-R3	



Data sheets → Internet: clevis foot

Accessories

Ordering data – Piston rod attachments



Designation	For ø	Part no.	Type
Rod eye SGS			
	12	9254	SGS-M6
	16	9255	SGS-M8
	20	9261	SGS-M10x1.25
	25		
	32		
	40		
	50	9262	SGS-M12x1.25
	63		
	80	9263	SGS-M16x1.5
	100	9264	SGS-M20x1.5
125	10774	SGS-M27x2	
Rod clevis SG			
	12	3110	SG-M6
	16	3111	SG-M8
	20	6144	SG-M10x1.25
	25		
	32		
	40		
	50	6145	SG-M12x1.25
	63		
80	6146	SG-M16x1.5	
	100	6147	SG-M20x1.5
	125	14987	SG-M27x2-B
Coupling piece KSG			
	12	–	–
	16		
	20	32963	KSG-M10x1.25
	25		
	32		
	40		
	50	32964	KSG-M12x1.25
	63		
	80	32965	KSG-M16x1.5
	100	32966	KSG-M20x1.5
125	32967	KSG-M27x2	
Adapter AD			
	12	157328	AD-M6-M5
		157329	AD-M6-1/8
		157330	AD-M6-1/4
	16	157331	AD-M8-1/8
		157332	AD-M8-1/4
	20	157333	AD-M10x1.25-1/8
	25	157334	AD-M10x1.25-1/4
	32		
	40		
	50	160256	AD-M12x1.25-1/4
63	160257	AD-M12x1.25-3/8	

Data sheets → Internet: piston rod attachment

Designation	For ø	Part no.	Type
Rod clevis SGA			
	12	–	–
	16		
	20	32954	SGA-M10x1.25
	25		
	32		
	40		
	50	10767	SGA-M12x1.25
	63		
	80	10768	SGA-M16x1.5
	100	10769	SGA-M20x1.5
125	10770	SGA-M27x2	
Self-aligning rod coupler FK			
	12	2061	FK-M6
	16	2062	FK-M8
	20	6140	FK-M10x1.25
	25		
	32		
	40		
	50	6141	FK-M12x1.25
	63		
	80	6142	FK-M16x1.5
	100	6143	FK-M20x1.5
125	10485	FK-M27x2	
Coupling piece KSZ			
	12	36123	KSZ-M6
	16	36124	KSZ-M8
	20	36125	KSZ-M10x1.25
	25		
	32		
	40		
	50	36126	KSZ-M12x1.25
	63		
	80	36127	KSZ-M16x1.5
	100	36128	KSZ-M20x1.5
125	–	–	

Accessories

Ordering data – Piston-rod attachments, corrosion-resistant



Designation	For ø	Part no.	Type
Rod eye CRSGS			
	12	195580	CRSGS-M6
	16	195581	CRSGS-M8
	20	195582	CRSGS-M10x1.25
	25		
	32		
	40		
	50	195583	CRSGS-M12x1.25
	63		
	80	195584	CRSGS-M16x1.5
	100	195585	CRSGS-M20x1.5
	125	195586	CRSGS-M27x2
Self-aligning rod coupler CRFK			
	20	2305778	CRFK-M10x1.25
	25		
	32		
	40		
	50	2305779	CRFK-M12x1.25
	63		
	80	2490673	CRFK-M16x1.5
100	2545677	CRFK-M20x1.5	

Data sheets → Internet: piston rod attachment









Designation	For ø	Part no.	Type
Rod clevis CRSG			
	12	13567	CRSG-M6
	16	13568	CRSG-M8
	20	13569	CRSG-M10x1.25
	25		
	32		
	40		
	50	13570	CRSG-M12x1.25
	63		
	80	13571	CRSG-M16x1.5
	100	13572	CRSG-M20x1.5
	125	185361	CRSG-M27x2

Ordering data – One-way flow control valves

Data sheets → Internet: grl

	Connection		Material	Part no.	Type		
	Thread	For tubing O.D.					
For exhaust air							
	M5	3	Metal design	193137	GRLA-M5-QS-3-D		
		4		193138	GRLA-M5-QS-4-D		
		6		193139	GRLA-M5-QS-6-D		
	G1/8	3		193142	GRLA-1/8-QS-3-D		
		4		193143	GRLA-1/8-QS-4-D		
		6		193144	GRLA-1/8-QS-6-D		
		8		193145	GRLA-1/8-QS-8-D		
	G1/4	6		193146	GRLA-1/4-QS-6-D		
		8		193147	GRLA-1/4-QS-8-D		
		10		193148	GRLA-1/4-QS-10-D		
	For supply air						
		M5		3	Metal design	193153	GRLZ-M5-QS-3-D
4			193154	GRLZ-M5-QS-4-D			
6			193155	GRLZ-M5-QS-6-D			
G1/8		3	193156	GRLZ-1/8-QS-3-D			
		4	193157	GRLZ-1/8-QS-4-D			
		6	193158	GRLZ-1/8-QS-6-D			
		8	193159	GRLZ-1/8-QS-8-D			

Accessories

Ordering data – Proximity switch for T-slot, magneto-resistive						Data sheets → Internet: smt
	Type of mounting	Switching output	Electrical connection	Cable length [m]	Part no.	Type
N/O						
	Inserted in the slot from above, flush with the cylinder profile, short design	PNP	Cable, 3-wire	2.5	574335	SMT-8M-A-PS-24V-E-2.5-OE
			Plug M8x1, 3-pin	0.3	574334	SMT-8M-A-PS-24V-E-0.3-M8D
			Plug M12x1, 3-pin	0.3	574337	SMT-8M-A-PS-24V-E-0.3-M12
		NPN	Cable, 3-wire	2.5	574338	SMT-8M-A-NS-24V-E-2.5-OE
			Plug M8x1, 3-pin	0.3	574339	SMT-8M-A-NS-24V-E-0.3-M8D
N/C contact						
	Inserted in the slot from above, flush with the cylinder profile, short design	PNP	Cable, 3-wire	7.5	574340	SMT-8M-A-PO-24V-E-7.5-OE
Ordering data – Proximity switch for T-slot, magnetic reed						Data sheets → Internet: sme
	Type of mounting	Switching output	Electrical connection	Cable length [m]	Part no.	Type
N/O						
	Inserted in the slot from above, flush with the cylinder profile	Contacting	Cable, 3-wire	2.5	543862	SME-8M-DS-24V-K-2.5-OE
			5.0	543863	SME-8M-DS-24V-K-5.0-OE	
			Cable, 2-wire	2.5	543872	SME-8M-ZS-24V-K-2.5-OE
			Plug M8x1, 3-pin	0.3	543861	SME-8M-DS-24V-K-0.3-M8D
	Inserted in the slot lengthwise, flush with the cylinder profile	Contacting	Cable, 3-wire	2.5	150855	SME-8-K-LED-24
			Plug M8x1, 3-pin	0.3	150857	SME-8-S-LED-24
N/C contact						
	Inserted in the slot lengthwise, flush with the cylinder profile	Contacting	Cable, 3-wire	7.5	160251	SME-8-O-K-LED-24
Ordering data – Connecting cables						Data sheets → Internet: nebu
	Electrical connection, left	Electrical connection, right	Cable length [m]	Part no.	Type	
	Straight socket, M8x1, 3-pin	Cable, open end, 3-wire	2.5	541333	NEBU-M8G3-K-2.5-LE3	
			5.0	541334	NEBU-M8G3-K-5-LE3	
	Straight socket, M12x1, 5-pin	Cable, open end, 3-wire	2.5	541363	NEBU-M12G5-K-2.5-LE3	
			5.0	541364	NEBU-M12G5-K-5-LE3	
	Angled socket, M8x1, 3-pin	Cable, open end, 3-wire	2.5	541338	NEBU-M8W3-K-2.5-LE3	
			5.0	541341	NEBU-M8W3-K-5-LE3	
	Angled socket, M12x1, 5-pin	Cable, open end, 3-wire	2.5	541367	NEBU-M12W5-K-2.5-LE3	
			5.0	541370	NEBU-M12W5-K-5-LE3	
Ordering data – Slot cover for T-slot						
	Mounting	Length	Part no.	Type		
	Insertable	2x 0.5 m	151680	ABP-5-S		

Festo - Your Partner in Automation



1 Festo Inc.
5300 Explorer Drive
Mississauga, ON L4W 5G4
Canada

Festo Customer Interaction Center
Tel: 1 877 463 3786
Fax: 1 877 393 3786
Email: customer.service.ca@festo.com

2 Festo Pneumatic
Av. Ceylán 3,
Col. Tequesquináhuac
54020 Tlalneantla,
Estado de México

Multinational Contact Center
01 800 337 8669
ventas.mexico@festo.com

3 Festo Corporation
1377 Motor Parkway
Suite 310
Islandia, NY 11749

Festo Customer Interaction Center
1 800 993 3786
1 800 963 3786
customer.service.us@festo.com

4 Regional Service Center
7777 Columbia Road
Mason, OH 45040

Connect with us



www.festo.com/socialmedia



www.festo.com

Subject to change